

Cameleon System

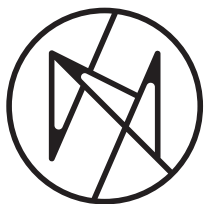

Nowodvorski
LIGHTING



Nowodvorski
LIGHTING

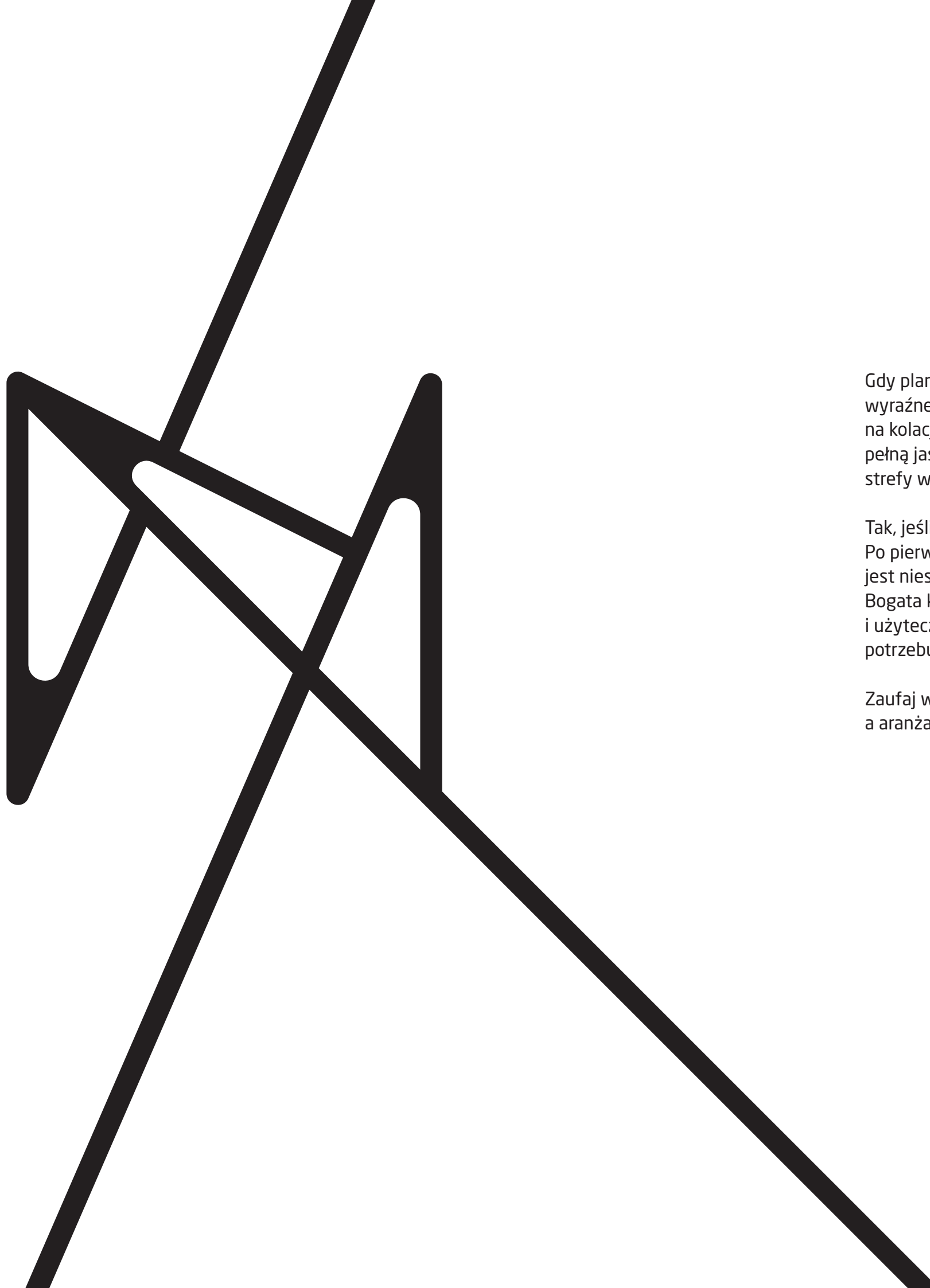

Gdy planujesz zatopić się wieczorem w lekturze ulubionej książki, potrzebujesz wyraźnego światła nad swoim wygodnym fotelem. Kiedy zapraszasz przyjaciół na kolację, chcesz stworzyć bardziej przytulną atmosferę w salonie, zachowując pełną jasność w kuchni. Zastanawiasz się czy indywidualne oświetlenie każdej strefy w otwartej przestrzeni jest możliwe w ramach jednej spójnej aranżacji?

Tak, jeśli wybierzesz system Cameleon. Co Cię w nim zachwyci? Po pierwsze możliwości. Ilość kompozycji, które możesz stworzyć za jego pomocą jest nieskończona. Nic Cię nie ogranicza. Po drugie kreatywność. Bogata kolekcja i elastyczność systemu pozwolą Ci zaprojektować niebanalną i użyteczną przestrzeń, która za każdym razem rozbłyśnie dokładnie tak jak tego potrzebujesz. Tylko pomyśl jak piękne i oryginalne wnętrza możesz wykreować.

Zaufaj własnej wyobraźni i kreatywnemu systemowi Cameleon, a aranżacja wnętrza stanie się prostsza!

Когда планируете вечером погрузиться в чтение любимой книги, Вам нужен четкий направленный свет над Вашим любимым креслом. Когда приглашаете друзей на ужин, Вы хотите создать более уютную атмосферу в гостиной, сохраняя полное освещение на кухне. Задумываетесь ли Вы, возможно ли создать индивидуальное освещение каждой зоны в рамках одной комплексной системы?

Да, возможно. Если Вы выберете систему Cameleon. Что в ней вызовет Ваше восхищение? Во-первых, возможности. Количество композиций, которые Вы можете создать с его помощью, - бесконечно. Ничто Вас не ограничивает. Во-вторых, креативность. Богатая коллекция и эластичность системы позволит Вам спроектировать уникальное и практичное пространство, которое будет сиять так, как Вам это нужно. Только подумайте, какой красивый и оригинальный интерьер Вы можете создать.

Доверьтесь собственному воображению и креативной системе Cameleon, и обустройство интерьера станет проще!

When you're planning to immerse yourself in your favourite book in the evening, you need a clear light above your comfortable armchair. When you invite friends for dinner, you want to create a more cosy atmosphere in the living room while maintaining full brightness in the kitchen. Are you wondering whether it is possible to illuminate each zone in an open space individually within one coherent design?

Yes, if you choose the Cameleon system. What will impress you about it? First of all, the possibilities. The number of compositions you can create with it is endless. Nothing limits you. Secondly, creativity. The extensive collection and flexibility of the system will allow you to design an original and usable space, that will always be lit just how you want it. Just think how beautiful and original interior you can create.

Trust your imagination and the creative Cameleon system, and interior design will become easier!

CAMELEON SYSTEM



POLARIS 34-35



MONACO 36-37



SNOWBALL 38-39



SPHERE 40-41



PEAR 44-45



CYLINDER 48



STRAW 49



EYE 50-51



LASER 52-57



CANDY 60-61



HERMANOS 62-63



ZENITH 64-65



EGG 66-67



WAVE 70



LUKSOR 71



PICO 72-73



GSTAR 74-75



WHEEL 76-77



DOVER 78-81



GEOMETRIC 82-83



CONE 86-89



BARREL 92-95



ADAPTER CTLS 96-97



ADAPTER PROFILE 98-99



CABLE 100-101



CANOPY 102-106



FIXING 108-109



BULBS 110-111

CAMELEON SYSTEM

UNLIMITED POSSIBILITIES

NIEOGRANICZONE MOŻLIWOŚCI

НЕОГРАНИЧЕННЫЕ ВОЗМОЖНОСТИ



HOW IT WORKS?

JAK TO DZIAŁA?

КАК ЭТО РАБОТАЕТ?

CHOOSE

WYBIERZ

ВЫБРАТЬ

BUY

KUP

КУПИТЬ

ASSEMBLE

ZŁÓŻ

СОБИРАТЬ

CREATE YOUR OWN LIGHT SYSTEM USING OUR ELEMENTS

STWÓRZ SWÓJ SYSTEM ŚWIETLNY WYBIERAJĄC NASZE ELEMENTY

СОЗДАЙ СВОЙ СВЕТ, ВЫБИРАЯ НАШИ КОМПОНЕНТЫ

SCAN QR CODE TO LEARN HOW IT WORKS

ZESKANUJ KOD QR ABY DOWIEDZIEĆ SIĘ WIĘCEJ

СКАНИРУЙТЕ QR-КОД, ЧТОБЫ УЗНАТЬ, КАК ОНО РАБОТАЕТ



CAMELEON CANOPY A

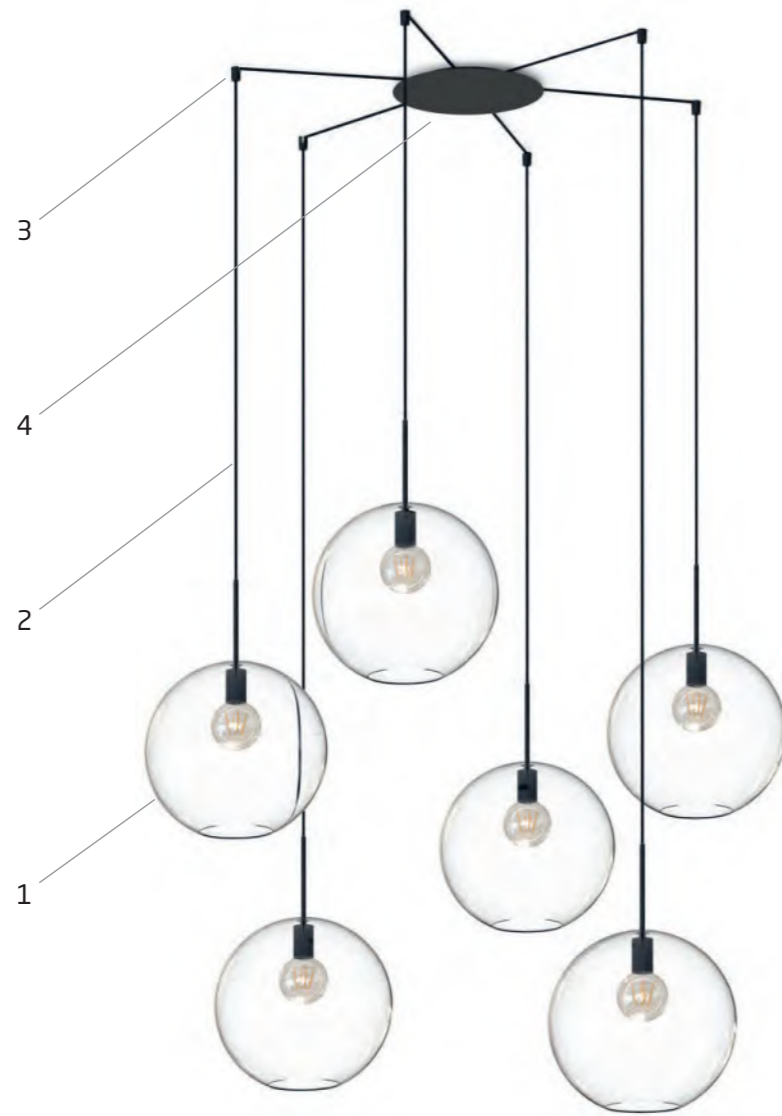

ELEMENTS USED IN THE CONFIGURATION / ELEMENTY UŻYTE W KONFIGURACJI / ЭЛЕМЕНТЫ, ИСПОЛЬЗУЕМЫЕ В КОНФИГУРАЦИИ

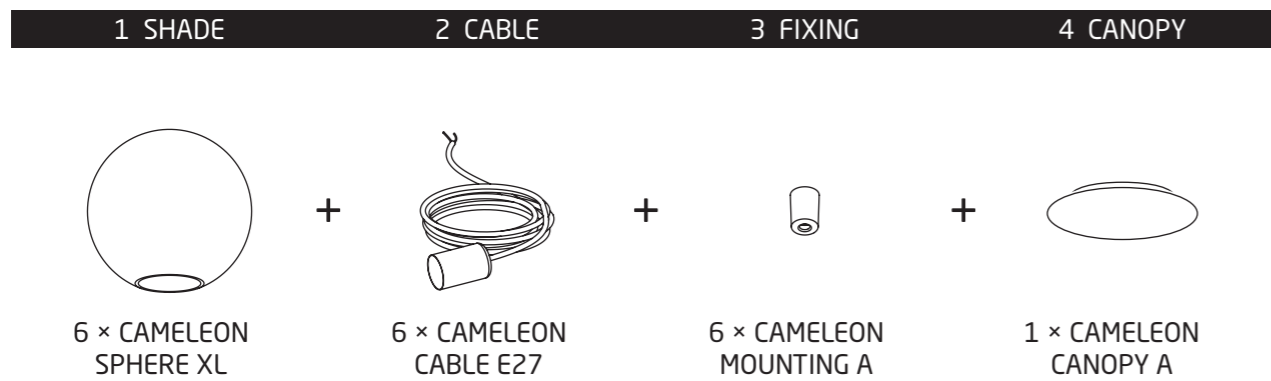

CAMELEON CANOPY A MINI



ELEMENTS USED IN THE CONFIGURATION / ELEMENTY UŻYTE W KONFIGURACJI / ЭЛЕМЕНТЫ, ИСПОЛЬЗУЕМЫЕ В КОНФИГУРАЦИИ

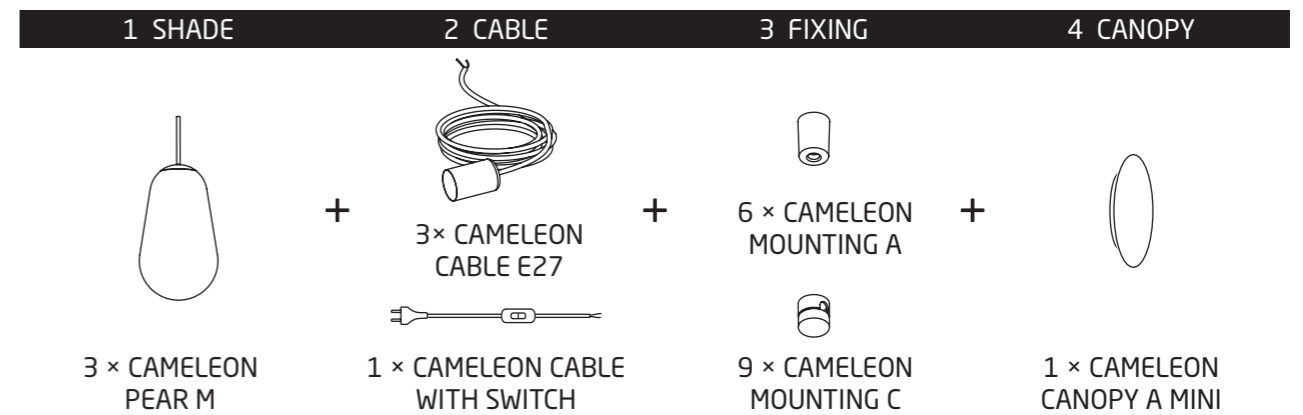

CAMELEON CANOPY H

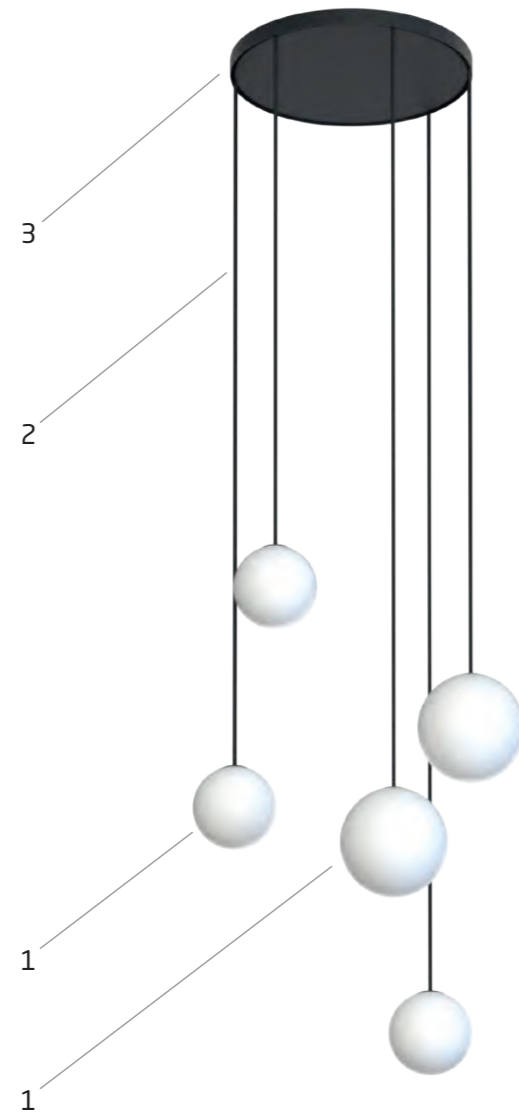

ELEMENTS USED IN THE CONFIGURATION / ELEMENTY UŻYTE W KONFIGURACJI / ЭЛЕМЕНТЫ, ИСПОЛЬЗУЕМЫЕ В КОНФИГУРАЦИИ

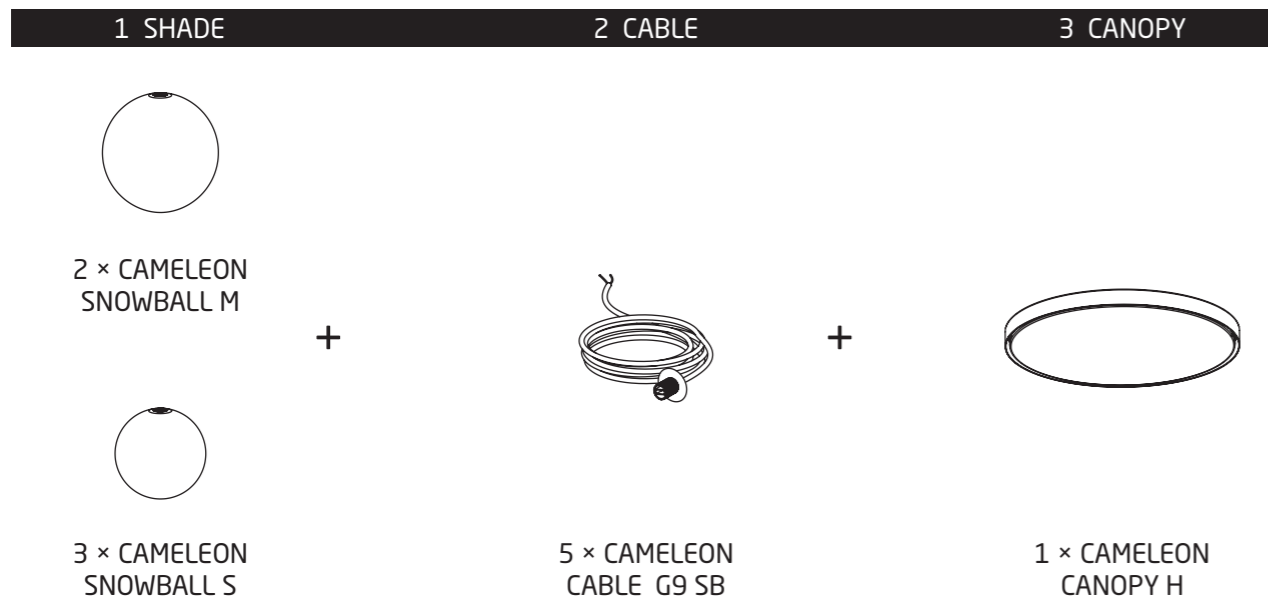

CAMELEON CANOPY D

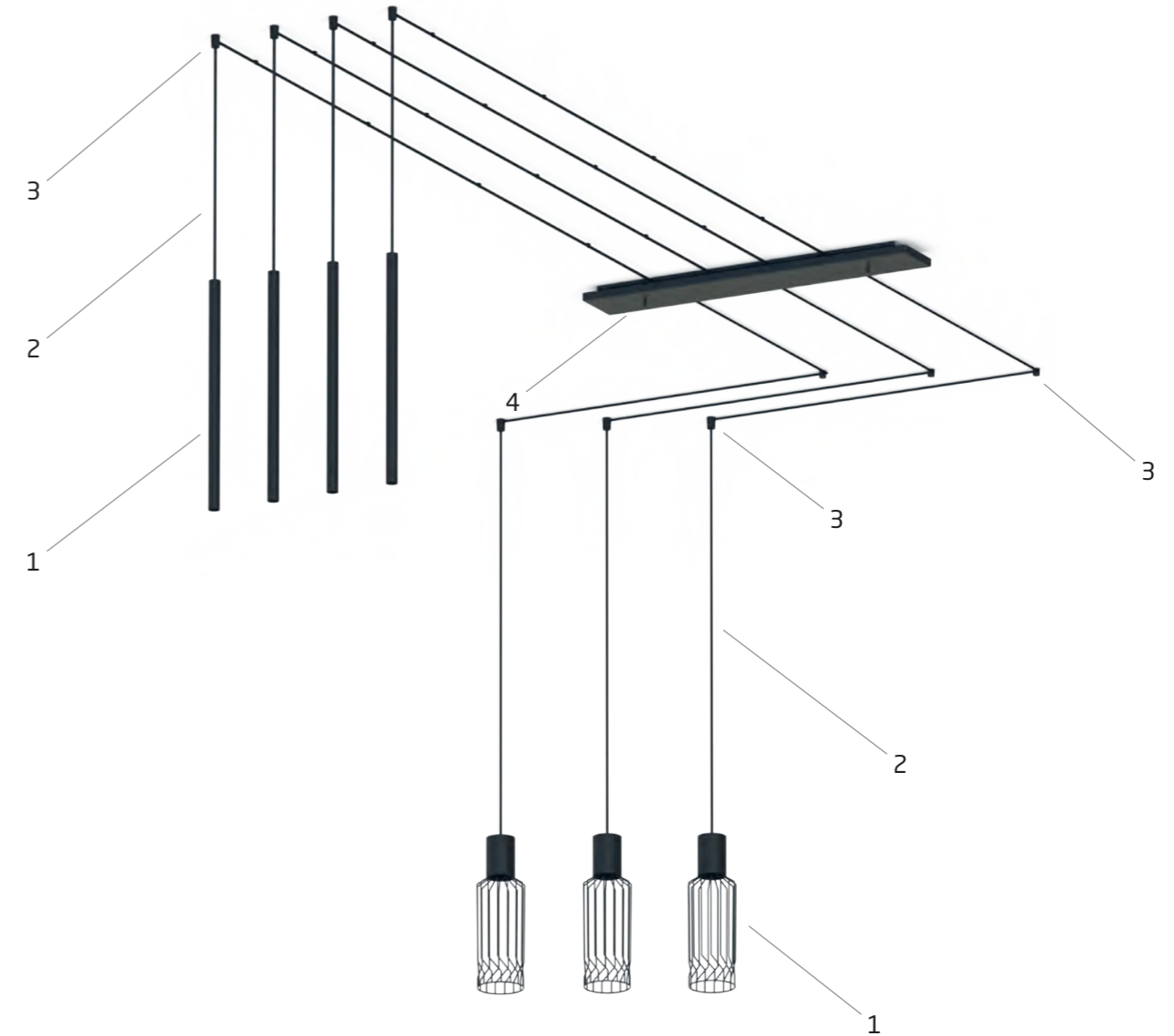

ELEMENTS USED IN THE CONFIGURATION / ELEMENTY UŻYTE W KONFIGURACJI / ЭЛЕМЕНТЫ, ИСПОЛЬЗУЕМЫЕ В КОНФИГУРАЦИИ

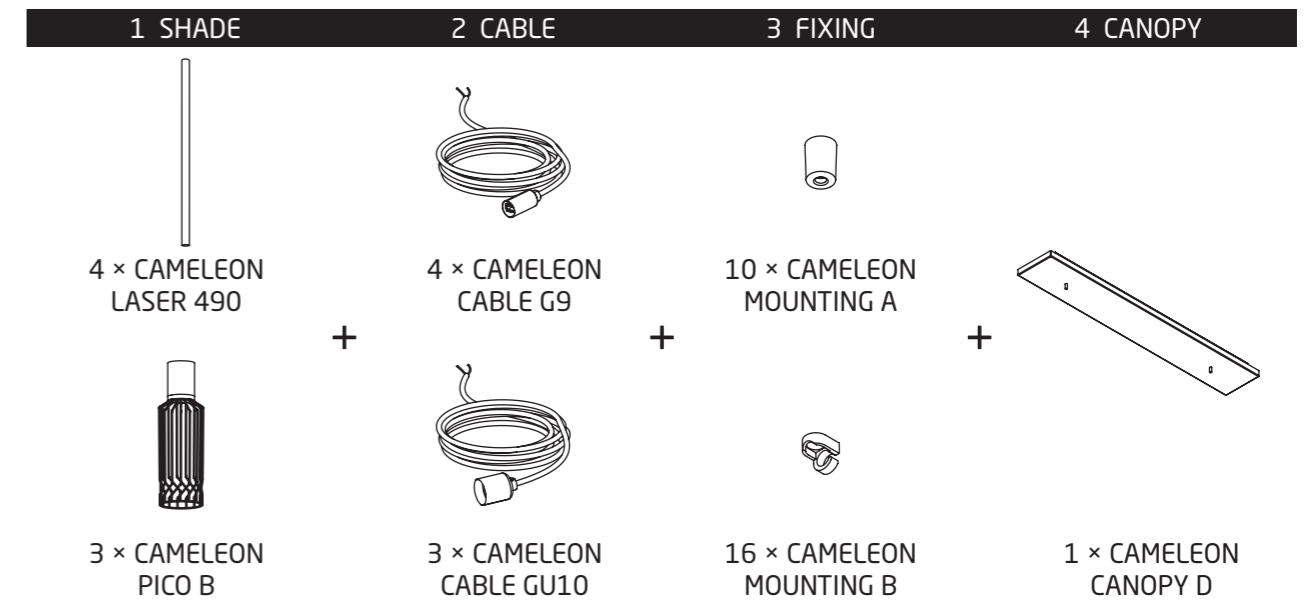

CAMELEON CANOPY B 780

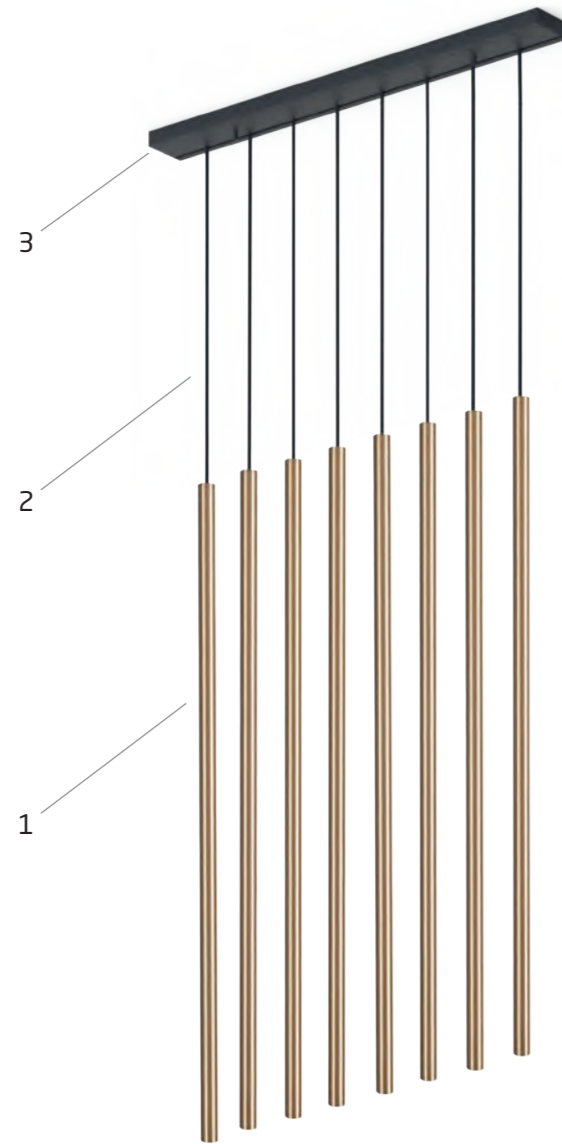

CAMELEON CANOPY C 780

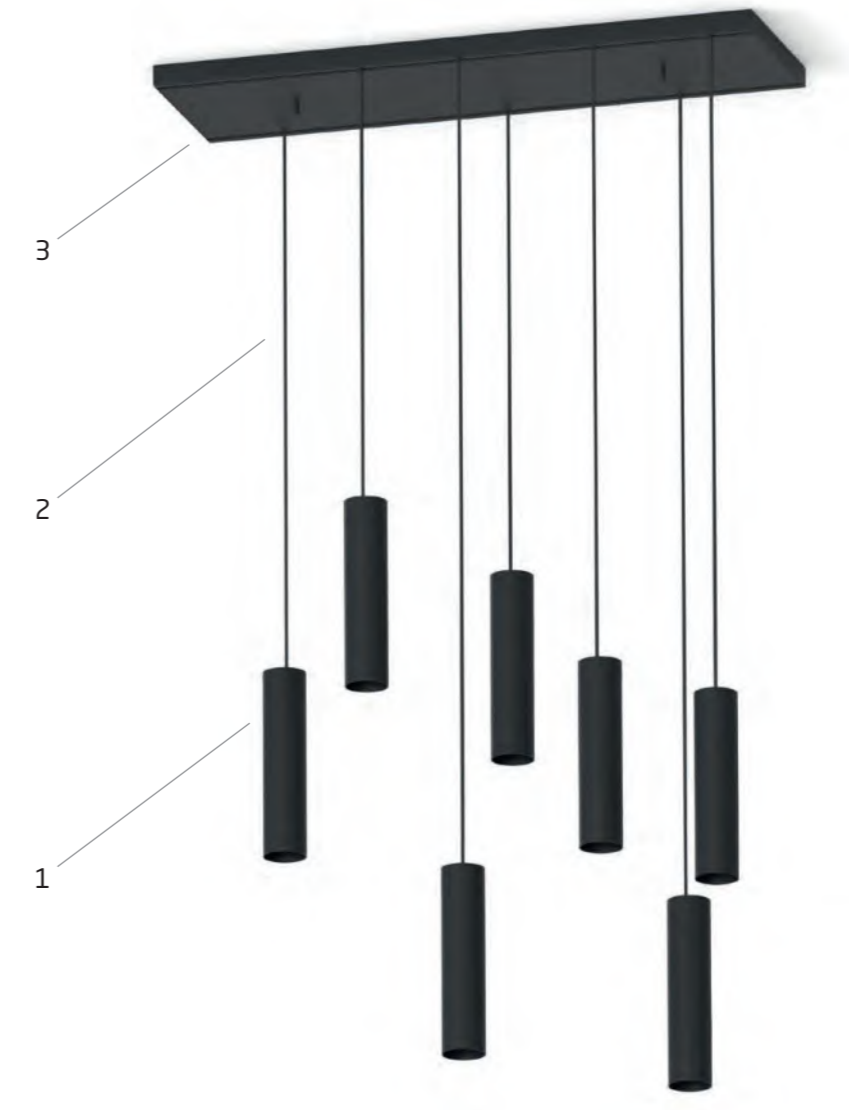

ELEMENTS USED IN THE CONFIGURATION / ELEMENTY UŻYTE W KONFIGURACJI / ЭЛЕМЕНТЫ, ИСПОЛЬЗУЕМЫЕ В КОНФИГУРАЦИИ

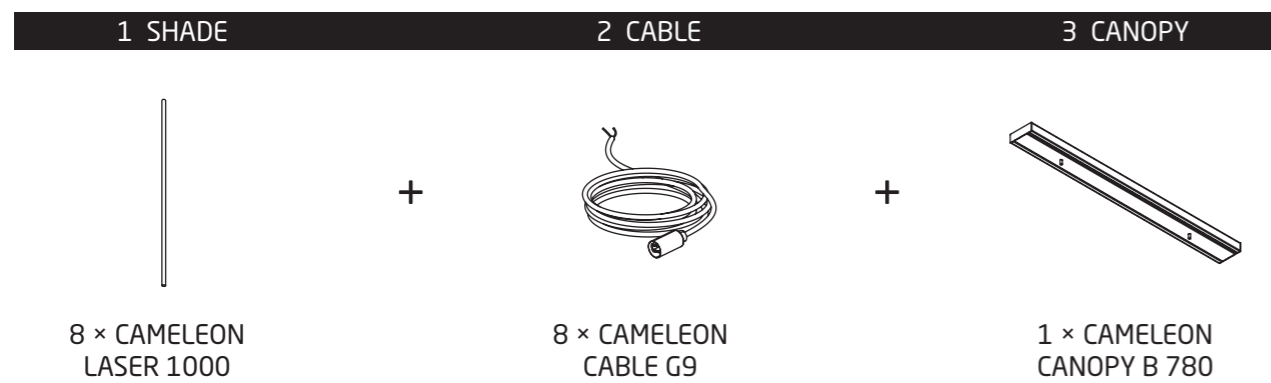

ELEMENTS USED IN THE CONFIGURATION / ELEMENTY UŻYTE W KONFIGURACJI / ЭЛЕМЕНТЫ, ИСПОЛЬЗУЕМЫЕ В КОНФИГУРАЦИИ

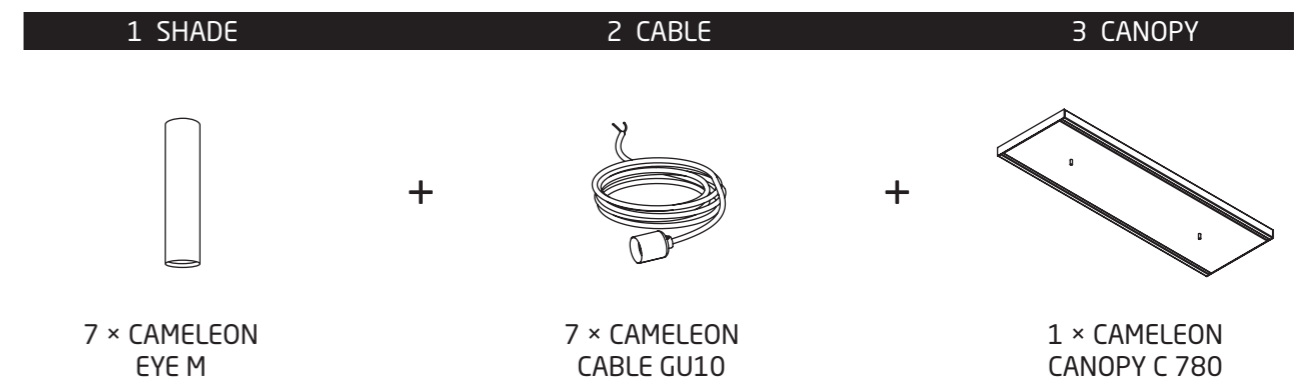

CAMELEON CANOPY E

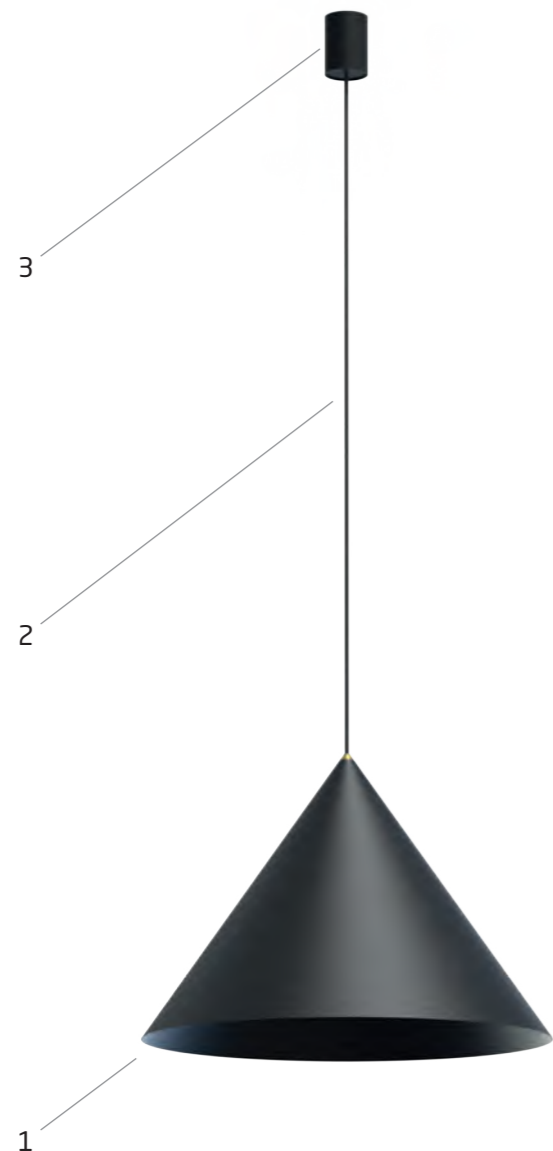

ELEMENTS USED IN THE CONFIGURATION / ELEMENTY UŻYTE W KONFIGURACJI / ЭЛЕМЕНТЫ, ИСПОЛЬЗУЕМЫЕ В КОНФИГУРАЦИИ

1 SHADE 2 CABLE 3 CANOPY

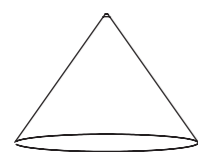

1 × CAMELEON
ZENITH L

+



1 × CAMELEON
CABLE GU10

+



1 × CAMELEON
CANOPY E

CAMELEON CANOPY F

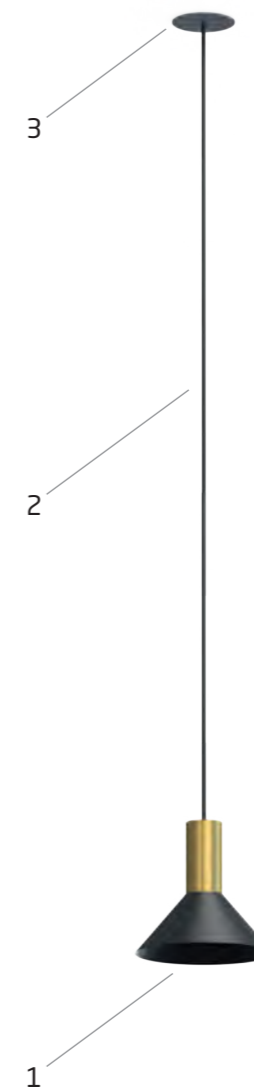

ELEMENTS USED IN THE CONFIGURATION / ELEMENTY UŻYTE W KONFIGURACJI / ЭЛЕМЕНТЫ, ИСПОЛЬЗУЕМЫЕ В КОНФИГУРАЦИИ

1 SHADE 2 CABLE 3 CANOPY



1 × CAMELEON
HERMANOS

+

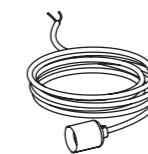

1 × CAMELEON
CABLE GU10

+



1 × CAMELEON
CANOPY F

CAMELEON ADAPTER PROFILE



ELEMENTS USED IN THE CONFIGURATION / ELEMENTY UŻYTE W KONFIGURACJI / ЭЛЕМЕНТЫ, ИСПОЛЬЗУЕМЫЕ В КОНФИГУРАЦИИ

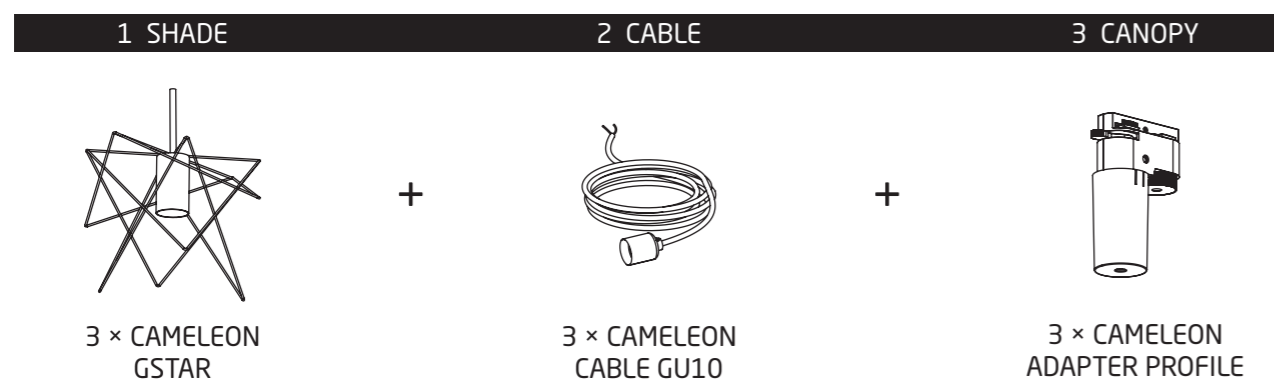

PROFILE - 1 CIRCUIT TRACK LIGHT SYSTEM

CAMELEON ADAPTER CTLS



ELEMENTS USED IN THE CONFIGURATION / ELEMENTY UŻYTE W KONFIGURACJI / ЭЛЕМЕНТЫ, ИСПОЛЬЗУЕМЫЕ В КОНФИГУРАЦИИ



CTLS - 3 CIRCUITS TRACK LIGHT SYSTEM

CHOOSE

CHOOSE ELEMENTS TO CREATE PERFECTLY FUNCTIONAL LAMP FOR YOUR HOME

WYBIERZ

WYBIERZ ELEMENTY DO ZŁOŻENIA LAMPY IDEALNIE DOPASOWANEJ DO TWOJEGO DOMU

ВЫБРАТЬ

ВЫБЕРИТЕ ЭЛЕМЕНТЫ ДЛЯ СБОРКИ СВЕТИЛЬНИКА, ИДЕАЛЬНО ПОДОБРОННОГО К ВАШЕМУ ДОМУ

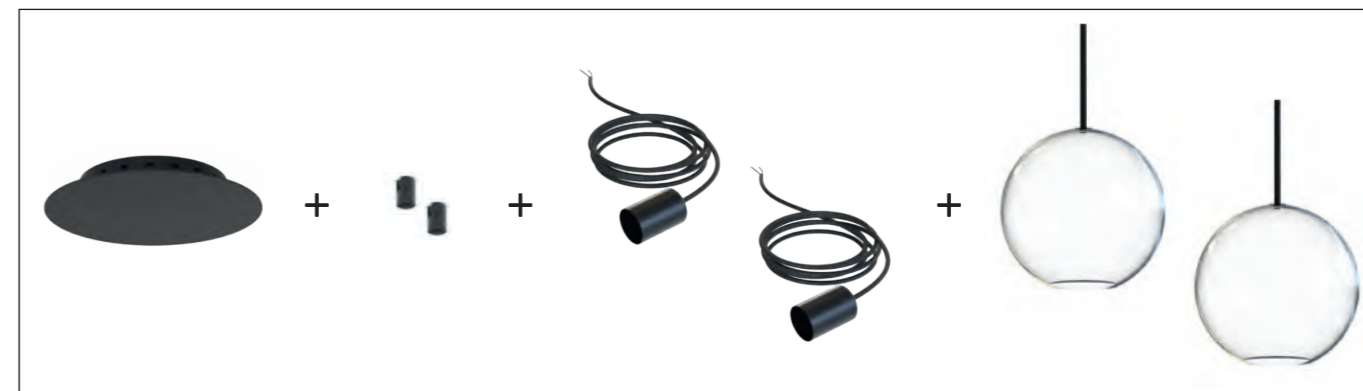

1. CHOOSE ELEMENTS TO CREATE PERFECTLY FUNCTIONAL LAMP FOR YOUR HOME

1. WYBIERZ ELEMENTY DO ZŁOŻENIA LAMPY IDEALNIE DOPASOWANEJ DO TWOJEGO DOMU

1. ВЫБЕРИТЕ ЭЛЕМЕНТЫ ДЛЯ СБОРКИ СВЕТИЛЬНИКА, ИДЕАЛЬНО ПОДОБРОННОГО К ВАШЕМУ ДОМУ

BUY

BUY CORRECT AMOUNT OF:

CAMELEON

- LAMP SHADES
- SUSPENSIONS
- CANOPIES
- FIXING ELEMENTS

KUP

ODPOWIEDNIĄ ILOŚĆ ELEMENTÓW:

CAMELEON

- KLOSZE
- ZAWIESZENIA
- PUSZKI
- AKCESORIA MONTAŻOWE

КУПИТЬ

ПРАВИЛЬНОЕ КОЛИЧЕСТВО ЭЛЕМЕНТОВ:

CAMELEON

- ПЛАФОНЫ
- ПОДВЕСЫ
- ОСНОВАНИЯ
- АКССУАРЫ ДЛЯ КРЕПЛЕНИЯ



2. PUT THE SUNSPENSION THROUGHT THE LAMP SHADE

2. PRZEŁÓŻ ZAWIESZENIE PRZEZ KLOSZ

2. ПЕРЕМЕСТИ ПОДВЕС ЧЕРЕЗ ПЛАФОН

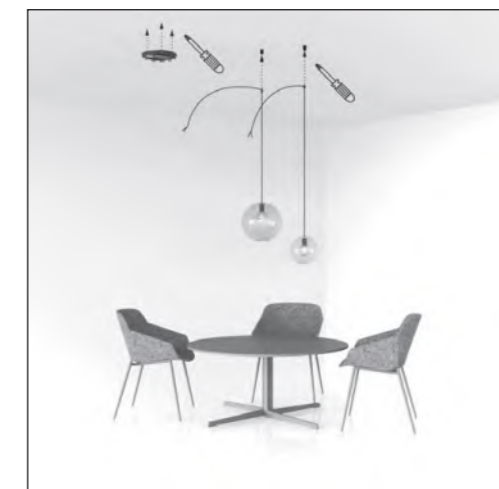

3. FIX THE CAMELEON CANOPY AND SUNSPENSION

3. PRZYKRĘĆ PUSZKĘ, ZAMOCUJ ZAWIESZENIE

3. ПРИВИНТИТЬ ОСНОВАНИЕ, КРЕПИТЬ ПОДВЕС

ASSEMBLE

EASY ASSEMBLING ACCORDING TO THE USER'S MANUAL

ZŁÓŻ

ŁATWY MONTAŻ WEDŁUG ZAŁĄCZONEJ INSTRUKCJI

СОБИРАТЬ

ЛЕГКАЯ СБОРКА В СООТВЕТСТВИИ С ПРИЛАГАЕМОЙ ИНСТРУКЦИЕЙ

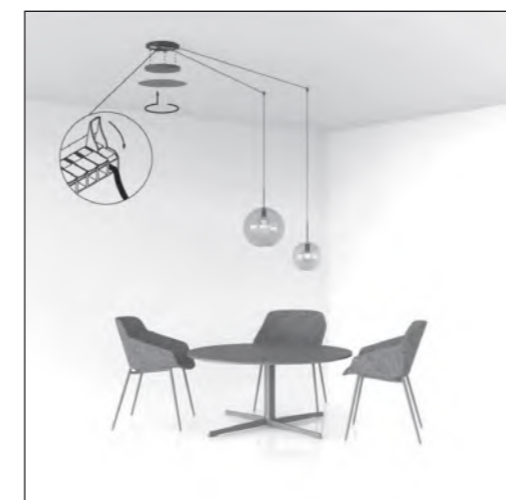

4. CONNECT THE SUNSPENSIONS TO THE CAMELEON CANOPY

4. PODŁĄCZ ZAWIESZENIA DO PUSZKI

4. ПОДКЛЮЧИТЬ ПОДВЕСЫ К ОСНОВАНИЮ CAMELEON

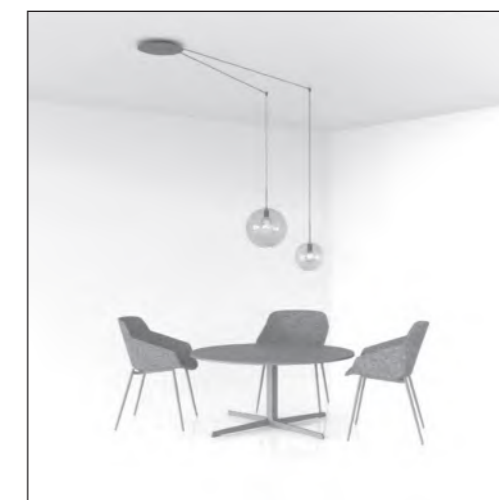

5. ENJOY FINAL RESULT

5. CIESZ SIĘ EFEKTEM KOŃCOWYM

5. НАСЛАЖДАЙТЕСЬ КОНЕЧНЫМ РЕЗУЛЬТАТОМ



inspiration



ELEMENTS USED IN THE CONFIGURATION / ELEMENTY UŻYTE W KONFIGURACJI / ЭЛЕМЕНТЫ, ИСПОЛЬЗУЕМЫЕ В КОНФИГУРАЦИИ

| | ELEMENT | ITEM NO. | PAGE |
|---|---------------|----------|------|
| 1 | CANOPY A MINI | 10018 | 102 |
| 2 | CABLE GU10 | 8630 | 101 |
| 3 | MOUNTING B | 8393 | 109 |
| 4 | MOUNTING A | 8395 | 108 |
| 5 | GEOMETRIC A | 8466 | 83 |
| 6 | GEOMETRIC C | 8465 | 83 |





ELEMENTS USED IN THE CONFIGURATION / ELEMENTY UŻYTE W KONFIGURACJI / ЭЛЕМЕНТЫ, ИСПОЛЬЗУЕМЫЕ В КОНФИГУРАЦИИ

| | ELEMENT | ITEM NO. | PAGE |
|---|---------------|----------|------|
| 1 | CANOPY C 1200 | 8555 | 105 |
| 2 | CABLE G9 | 8632 | 100 |
| 3 | CABLE GU10 | 8620 | 101 |
| 4 | CABLE GU10 | 8635 | 101 |
| 5 | LASER 490 | 8572 | 57 |
| 6 | EYE M | 8483 | 51 |
| 7 | EYE M | 8481 | 51 |
| 8 | EYE L | 8482 | 51 |





ELEMENTS USED IN THE CONFIGURATION / ELEMENTY UŻYTE W KONFIGURACJI / ЭЛЕМЕНТЫ, ИСПОЛЬЗУЕМЫЕ В КОНФИГУРАЦИИ

| | ELEMENT | ITEM NO. | PAGE |
|---|---------------|----------|------|
| 1 | CANOPY B 1500 | 8558 | 104 |
| 2 | CABLE GU10 | 8635 | 101 |
| 3 | CANDY | 10270 | 61 |





ELEMENTS USED IN THE CONFIGURATION / ELEMENTY UŻYTE W KONFIGURACJI / ЭЛЕМЕНТЫ, ИСПОЛЬЗУЕМЫЕ В КОНФИГУРАЦИИ

| ELEMENT | ITEM NO. | PAGE |
|-----------------|----------|------|
| 1 CANOPY A MINI | 10017 | 102 |
| 2 CABLE GU10 | 8614 | 101 |
| 3 MOUNTING A | 8396 | 108 |
| 4 ZENITH L | 8071 | 65 |

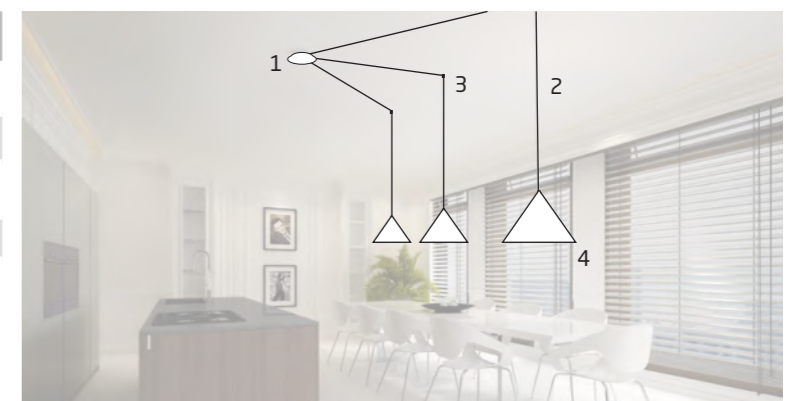



ELEMENTS FOR ASSEMBLY

ELEMENTY DO MONTAŽU

МОНТАЖНЫЕ ЭЛЕМЕНТЫ



CAMELEON POLARIS 10200



CAMELEON POLARIS 10201



CAMELEON POLARIS 10199



CAMELEON POLARIS 10202

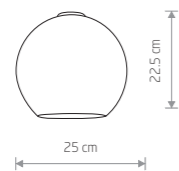

CAMELEON POLARIS
metallized glass, painted steel

10200 10201



works with / zastosuj z / применять с

1× CAMELEON CABLE E27

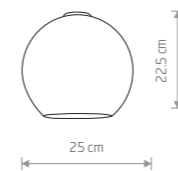

CAMELEON POLARIS
metallized glass, painted steel

10199



works with / zastosuj z / применять с

1× CAMELEON CABLE E27

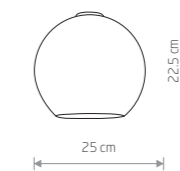

CAMELEON POLARIS
metallized glass, painted steel

10202



works with / zastosuj z / применять с

1× CAMELEON CABLE E27



CAMELEON MONACO
10205

CAMELEON MONACO
10203

CAMELEON MONACO
10204

CAMELEON MONACO
10205

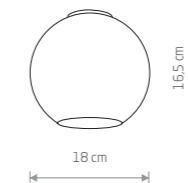

CAMELEON MONACO

glass, painted steel

■ 10205



works with / zastosuj z / применять с

● 1× CAMELEON CABLE E27

CAMELEON MONACO
10204

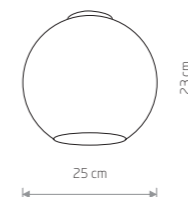

CAMELEON MONACO

glass, painted steel

■ 10204



works with / zastosuj z / применять с

● 1× CAMELEON CABLE E27

CAMELEON MONACO
10203

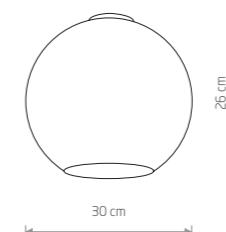

CAMELEON MONACO

glass, painted steel

■ 10203



works with / zastosuj z / применять с

● 1× CAMELEON CABLE E27

■ BLACK P013 RAL 9005

■ SMOKED



CAMELEON
ADAPTER PROFILE
8360

CAMELEON SNOWBALL
10267

CAMELEON
SNOWBALL
10267

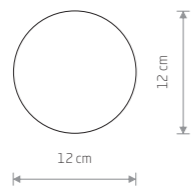

CAMELEON SNOWBALL 120

glass, steel

10267



works with / zastosuj z / применять с

1 × CAMELEON CABLE G9 SB



BULB LENS LED G9, 4W

7503 3000K

7504 4000K

CAMELEON
SNOWBALL
10268

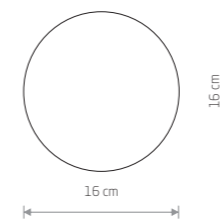

CAMELEON SNOWBALL 160

glass, steel

10268



works with / zastosuj z / применять с

1 × CAMELEON CABLE G9 SB



BULB LENS LED G9, 4W

7503 3000K

7504 4000K

WHITE

WHITE



CAMELEON SPHERE S
8531



CAMELEON SPHERE M
8530



CAMELEON SPHERE L
8528



CAMELEON SPHERE XL
8527

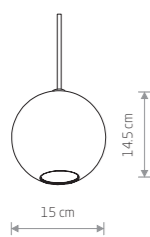

CAMELEON
SPHERE S

glass

□ 8531



works with / zastosuj z /
применять с

• 1× CAMELEON CABLE G9

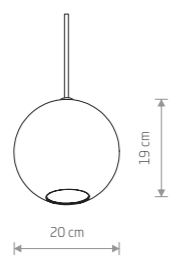

CAMELEON
SPHERE M

glass

□ 8530



works with / zastosuj z /
применять с

• 1× CAMELEON CABLE G9
• 1× CAMELEON CABLE E27

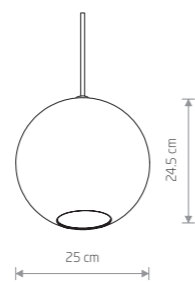

CAMELEON
SPHERE L

glass

□ 8528



works with / zastosuj z /
применять с

• 1× CAMELEON CABLE G9
• 1× CAMELEON CABLE E27

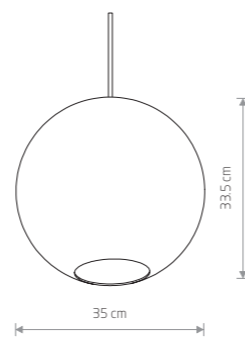

CAMELEON
SPHERE XL

glass

□ 8527



works with / zastosuj z /
применять с

• 1× CAMELEON CABLE G9
• 1× CAMELEON CABLE E27



CAMELEON SPHERE XL
8527



CAMELEON
CANOPY A
8563

CAMELEON
EYE M
8485

CAMELEON
PEAR S
8534

CAMELEON
CYLINDER L
8540

CAMELEON
EYE L
8484

CAMELEON
PEAR M
8533



CAMELEON PEAR S
8534

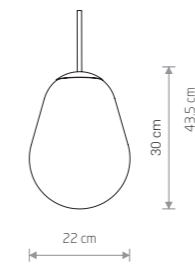

CAMELEON PEAR S

glass, brass-plated steel

8534 10331



works with / zastosuj z / применять с

- 1 × CAMELEON CABLE G9
- 1 × CAMELEON CABLE E27



CAMELEON PEAR M
8533

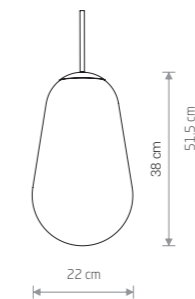

CAMELEON PEAR M

glass, brass-plated steel

8533 10330



works with / zastosuj z / применять с

- 1 × CAMELEON CABLE G9
- 1 × CAMELEON CABLE E27



CAMELEON PEAR L
8532

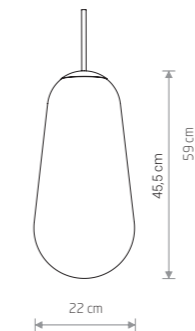

CAMELEON PEAR L

glass, brass-plated steel

8532 10328



works with / zastosuj z / применять с

- 1 × CAMELEON CABLE G9
- 1 × CAMELEON CABLE E27

CAMELEON
CANOPY A
8563

CAMELEON
CYLINDER M
8543

CAMELEON
EYE M
8485

CAMELEON
EYE L
8484

CAMELEON
CYLINDER S
8546





CAMELEON CYLINDER L
8540

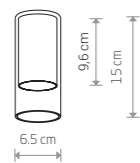

CAMELEON CYLINDER S
glass, painted steel

8544 8545



glass, solid brass

8546



works with / zastosuj z / применять с

1× CAMELEON CABLE GU10



CAMELEON CYLINDER S
8544

CAMELEON CYLINDER M
8542

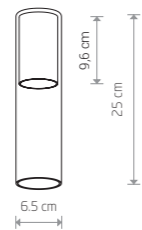

CAMELEON CYLINDER M
glass, painted steel

8541 8542



glass, solid brass

8543



works with / zastosuj z / применять с

1× CAMELEON CABLE GU10

1 x GU10 not included



CAMELEON CYLINDER L
glass, painted steel

8537 8538



glass, solid brass

8540



works with / zastosuj z / применять с

1× CAMELEON CABLE GU10

1 x G9 not included

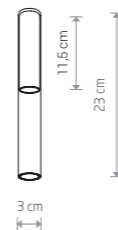

CAMELEON STRAW S

glass, painted steel

8400 8536



glass, solid brass

8401



works with / zastosuj z / применять с

1× CAMELEON CABLE G9

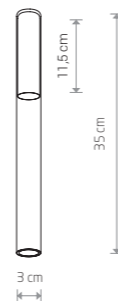

CAMELEON STRAW M

glass, painted steel

8402 8535



glass, solid brass

8403



works with / zastosuj z / применять с

1× CAMELEON CABLE G9



CAMELEON STRAW S
8401

CAMELEON STRAW S
8536



CAMELEON STRAW M
8402





CAMELEON EYE L
8484



CAMELEON EYE M
8485

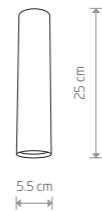

CAMELEON EYE M

solid brass

8485



works with / zastosuj z / применять с

1× CAMELEON CABLE GU10

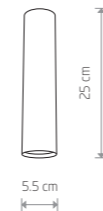

CAMELEON EYE M

painted steel

8483 8481



works with / zastosuj z / применять с

1× CAMELEON CABLE GU10



CAMELEON EYE M
8481



CAMELEON EYE L
8482



CAMELEON EYE L

solid brass

8484



works with / zastosuj z / применять с

1× CAMELEON CABLE GU10



CAMELEON EYE L

painted steel

8482 8480



works with / zastosuj z / применять с

1× CAMELEON CABLE GU10

CAMELEON
LASER 490
10248

CAMELEON
LASER 750
10253

CAMELEON
LASER 1000
10256

CAMELEON
LASER 1000
10255





CAMELEON LASER 490

painted steel

10248 10250 10251



works with / zastosuj z / применять с

1x CAMELEON CABLE G9

BULB LENS LED G9, 3W

9173 3000K 8447 4000K



CAMELEON LASER 750

painted steel

10252 10253 10254



works with / zastosuj z / применять с

1x CAMELEON CABLE G9

BULB LENS LED G9, 3W

9173 3000K 8447 4000K



CAMELEON LASER 1000

painted steel

10255 10256 10257



works with / zastosuj z / применять с

1x CAMELEON CABLE G9

BULB LENS LED G9, 3W

9173 3000K 8447 4000K



CAMELEON LASER 490 10248



CAMELEON LASER 750 10253



CAMELEON LASER 1000 10257



CAMELEON LASER 1000 10257

CAMELEON LASER 750 10254





CAMELEON
LASER 490
8573

CAMELEON
LASER 750
8570

CAMELEON
LASER 1000
8486

CAMELEON
LASER 750
8568

CAMELEON
LASER 490
8573

CAMELEON LASER 490

painted steel

8573 8572



solid brass

8571



works with / zastosuj z / применять с

1× CAMELEON CABLE G9

BULB LENS LED G9, 3W

9173 3000K 8447 4000K



CAMELEON LASER 750

painted steel

8570 8568



solid brass

8567



works with / zastosuj z / применять с

1× CAMELEON CABLE G9

BULB LENS LED G9, 3W

9173 3000K 8447 4000K



CAMELEON LASER 1000

painted steel

8487



solid brass

8486



works with / zastosuj z / применять с

1× CAMELEON CABLE G9

BULB LENS LED G9, 3W

9173 3000K 8447 4000K





CAMELEON
CANOPY E
8550

CAMELEON
CANDY
10261

CAMELEON
CANDY
10262

CAMELEON
CANDY
10263





CAMELEON CANDY
10271



CAMELEON CANDY
10270



CAMELEON CANDY
10262



CAMELEON CANDY
10261



CAMELEON CANDY
10263

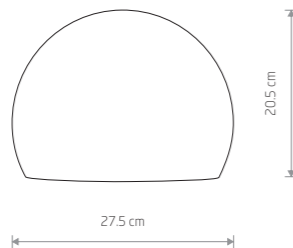

CAMELEON CANDY

painted steel

10270 10271



works with / zastosuj z / применять с

1× CAMELEON CABLE E27

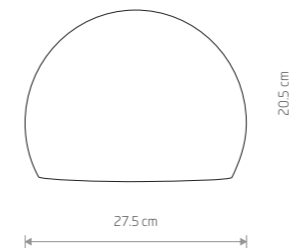

CAMELEON CANDY

painted steel

10261 10262 10263



works with / zastosuj z / применять с

1× CAMELEON CABLE E27



CAMELEON HERMANOS
8036

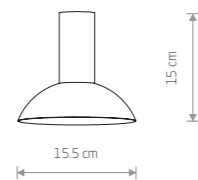

CAMELEON HERMANOS C

painteD steel, solid brass

8036



works with / zastosuj z / применять с

1× CAMELEON CABLE GU10



CAMELEON HERMANOS
8035

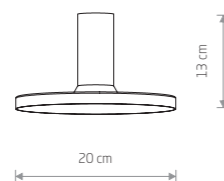

CAMELEON HERMANOS B

painteD steel, solid brass

8035



works with / zastosuj z / применять с

1× CAMELEON CABLE GU10



CAMELEON HERMANOS
8034

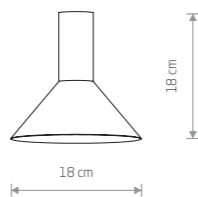

CAMELEON HERMANOS A

painteD steel, solid brass

8034



works with / zastosuj z / применять с

1× CAMELEON CABLE GU10

CAMELEON CANOPY B 1500
8558



CAMELEON HERMANOS
8034





CAMELEON ZENITH M
8066

CAMELEON ZENITH L
8067

CAMELEON ZENITH S
8065



CAMELEON ZENITH S
8068

CAMELEON ZENITH M
10196

CAMELEON ZENITH L
8067

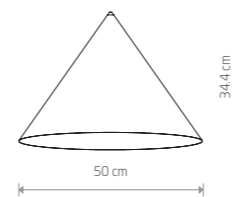

CAMELEON ZENITH L
painted steel, solid brass

8067 8071 10195



works with / zastosuj z / применять с

1 × CAMELEON CABLE GU10

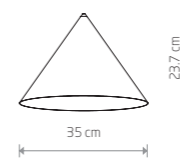

CAMELEON ZENITH M
painted steel, solid brass

8066 8070 10196



works with / zastosuj z / применять с

1 × CAMELEON CABLE GU10

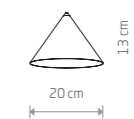

CAMELEON ZENITH S
painted steel, solid brass

8065 8068 10197



works with / zastosuj z / применять с

1 × CAMELEON CABLE GU10

BLACK P013 RAL 9005 WHITE P004 RAL 9003 GREEN P022 BRASS

CAMELEON EGG M
8607



CAMELEON EGG M
8607

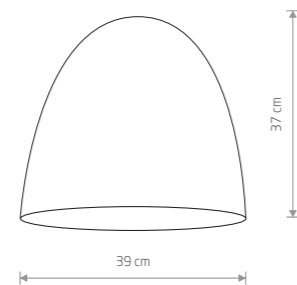

CAMELEON EGG M

composite

8607



works with / zastosuj z / применять с

1× CAMELEON CABLE E27

BLACK P014 RAL 9005 GOLD P018

CAMELEON CANOPY A
8563



CAMELEON WAVE S
8604

CAMELEON WAVE L
8602



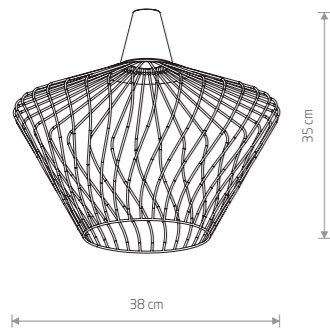

CAMELEON WAVE S

■ painted steel

■ 8605



■ brass-plated steel

■ 8604



works with / zastosuj z / применять с

💡 1× CAMELEON CABLE GU10

💡 1× CAMELEON CABLE E27

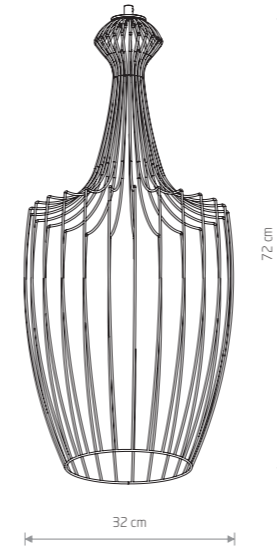

CAMELEON WAVE L

8604

CAMELEON LUKSOR L

■ painted steel

■ 8593



■ brass-plated steel

■ 8592



works with / zastosuj z / применять с

💡 1× CAMELEON CABLE E27

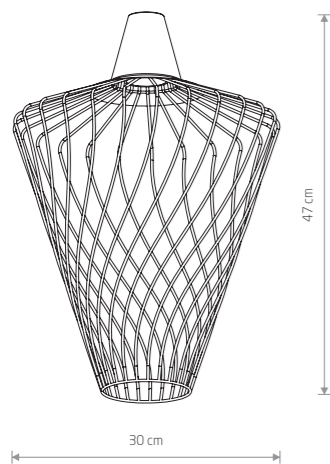

CAMELEON WAVE L

■ painted steel

■ 8602



■ brass-plated steel

■ 8600



works with / zastosuj z / применять с

💡 1× CAMELEON CABLE GU10

💡 1× CAMELEON CABLE E27

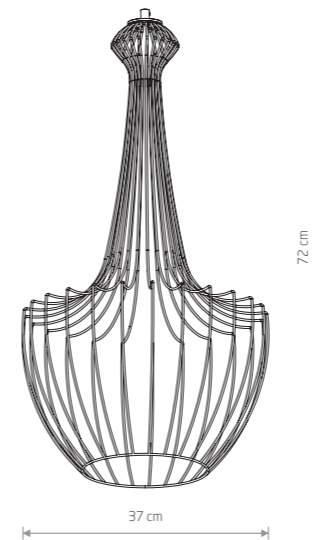

CAMELEON LUKSOR S

■ painted steel

■ 8597



■ brass-plated steel

■ 8596



works with / zastosuj z / применять с

💡 1× CAMELEON CABLE E27

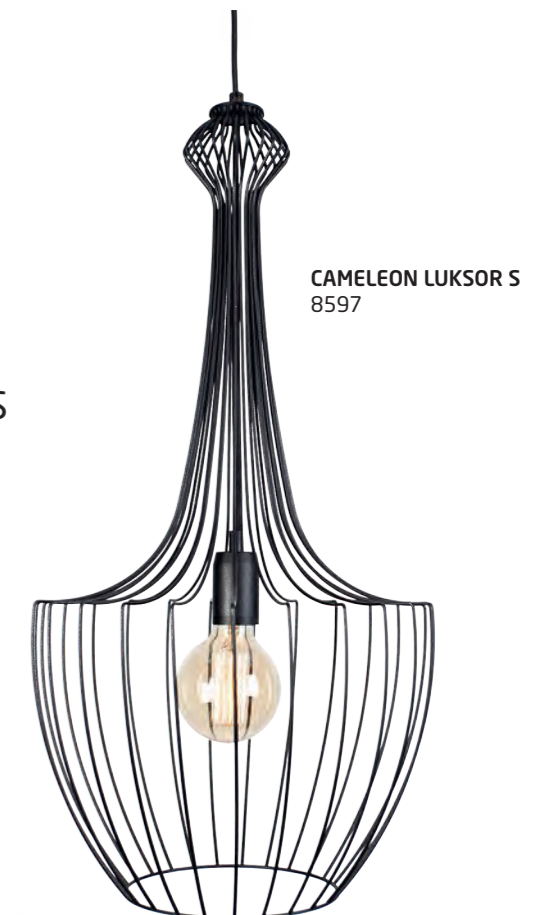



CAMELEON PICO A
8591



CAMELEON PICO B
8590



CAMELEON PICO C
8588

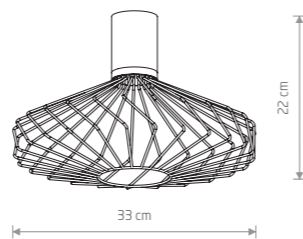
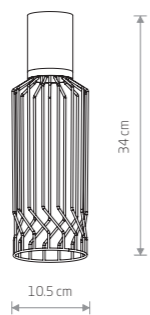
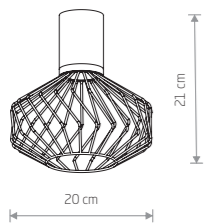

CAMELEON PICO A
painted steel, brass-plated steel

8591



works with / zastosuj z / применять с

1× CAMELEON CABLE GU10

CAMELEON PICO B
painted steel, brass-plated steel

8590



works with / zastosuj z / применять с

1× CAMELEON CABLE GU10

CAMELEON PICO C
painted steel, brass-plated steel

8588



works with / zastosuj z / применять с

1× CAMELEON CABLE GU10



CAMELEON CANOPY E
8550



CAMELEON PICO C
8588



CAMELEON GSTAR
10327



CAMELEON GSTAR
8576

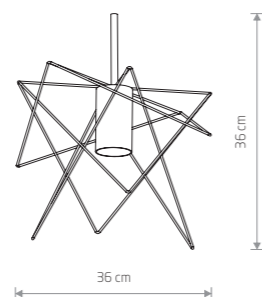

CAMELEON GSTAR
brass-plated steel, painted steel

8576 10327



works with / zastosuj z / применять с

1x CAMELEON CABLE GU10



CAMELEON WHEEL
8423

CAMELEON CANOPY A MINI
10018

CAMELEON WHEEL
8424



CAMELEON WHEEL
8423



CAMELEON WHEEL
8424

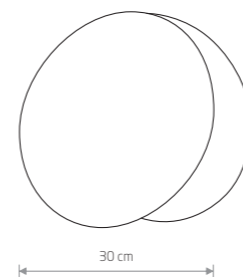

30 cm

CAMELEON WHEEL

plywood, painted steel

8423 8424



works with / zastosuj z / применять с

- 1× CAMELEON CABLE E27
- 1× CAMELEON CABLE GU10

GOLD BLACK P013 RAL 9005



CAMELEON
CANOPY E
8550

CAMELEON
DOVER
8463



CAMELEON DOVER
8463

CAMELEON CANOPY A MINI
10018



CAMELEON DOVER
8464



CAMELEON DOVER
8463

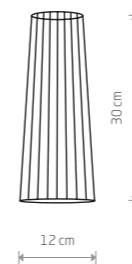

CAMELEON DOVER

plywood

8464 8463



works with / zastosuj z / применять с

1 × CAMELEON CABLE GU10

WOOD BLACK P013 RAL 9005

CAMELEON CANOPY B 1500
8608

CAMELEON GEOMETRIC A
8466



CAMELEON GEOMETRIC A
8466



CAMELEON GEOMETRIC B
8425



CAMELEON GEOMETRIC C
8465

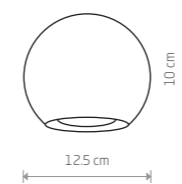

CAMELEON GEOMETRIC A
concrete

8466



works with / zastosuj z / применять с

1 × CAMELEON CABLE GU10

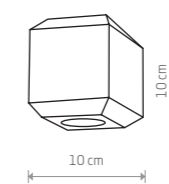

CAMELEON GEOMETRIC B
concrete

8425



works with / zastosuj z / применять с

1 × CAMELEON CABLE GU10

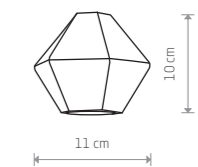

CAMELEON GEOMETRIC C
concrete

8465



works with / zastosuj z / применять с

1 × CAMELEON CABLE GU10



CAMELEON CONE L
8491



CAMELEON BARREL L
8508



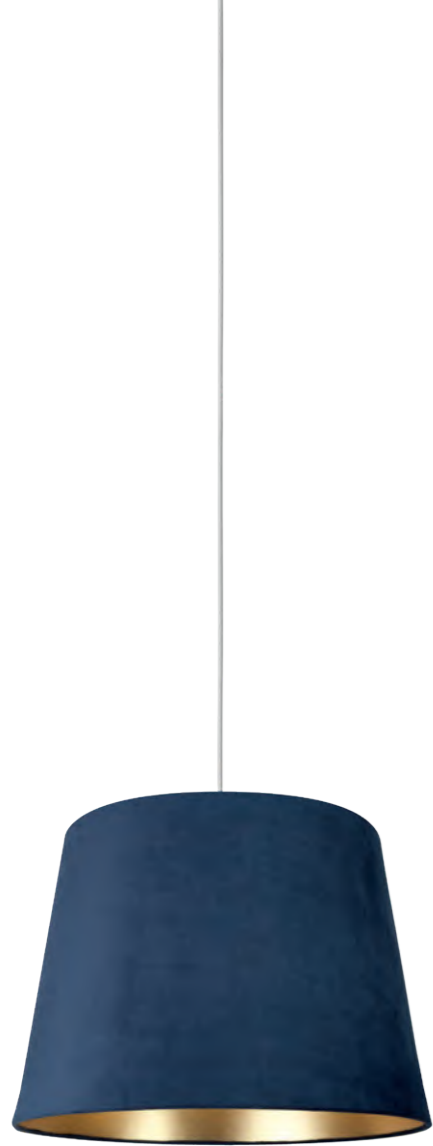

CAMELEON CONE M
8497



CAMELEON CONE M
8411



CAMELEON CONE M
8414



CAMELEON CONE L
8492



CAMELEON CONE L
8491



CAMELEON CONE L
8408

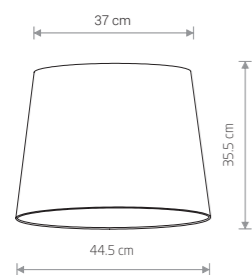

CAMELEON CONE M

fabric

8411 8413



velvet

8414 8496

8497 8495



works with / zastosuj z / применять с

1 × CAMELEON CABLE E27

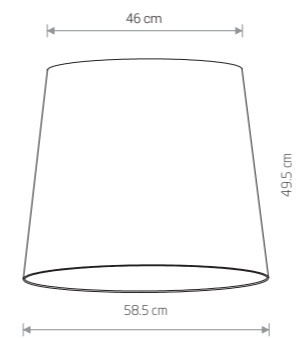

CAMELEON CONE L

fabric

8406 8408



velvet

8410 8492

8493 8491



works with / zastosuj z / применять с

1 × CAMELEON CABLE E27



CAMELEON CONE S
8501



CAMELEON CONE S
8503



CAMELEON CONE S
8415



CAMELEON CONE S
8500



CAMELEON CONE S
8504



CAMELEON CONE S
8416

CAMELEON CONE S

velvet

8501 8503 8415



works with / zastosuj z / применять с

- 1 × CAMELEON CABLE G9
- 1 × CAMELEON CABLE GU10
- 1 × CAMELEON CABLE E27

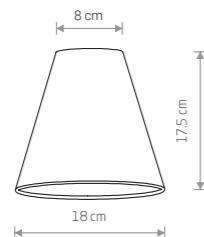

CAMELEON CONE S

fabric

8504 8416



velvet

8500



works with / zastosuj z / применять с

- 1 × CAMELEON CABLE G9
- 1 × CAMELEON CABLE GU10
- 1 × CAMELEON CABLE E27

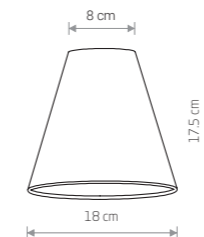

CAMELEON CONE S
8500

CAMELEON
BARREL THIN S
8521





CAMELEON
BARREL WIDE S
8518



CAMELEON
BARREL WIDE S
8516



CAMELEON
BARREL WIDE S
8514



CAMELEON
BARREL THIN S
8422



CAMELEON
BARREL THIN S
8520



CAMELEON
BARREL THIN S
8521

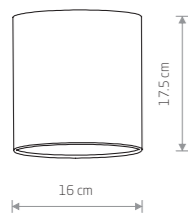

CAMELEON BARREL WIDE S

fabric

8516 8518



velvet

8512 8513

8514 8421



works with / zastosuj z / применять с

- 1× CAMELEON CABLE G9
- 1× CAMELEON CABLE GU10
- 1× CAMELEON CABLE E27

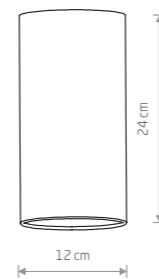

CAMELEON BARREL THIN S

fabric

8524 8526



velvet

8520 8521

8522 8422



works with / zastosuj z / применять с

- 1× CAMELEON CABLE G9
- 1× CAMELEON CABLE GU10
- 1× CAMELEON CABLE E27



CAMELEON BARREL L
8506



CAMELEON BARREL L
8418



CAMELEON BARREL L
8511



CAMELEON BARREL L
8508



CAMELEON BARREL L
8507



CAMELEON BARREL L
8417



CAMELEON BARREL L
8510

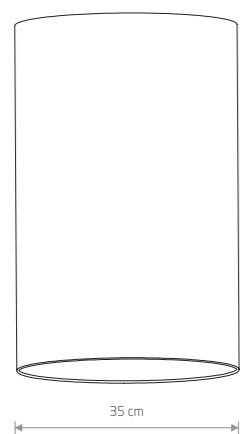

CAMELEON BARREL L

fabric

8418 8506



velvet

8511 8508



works with / zastosuj z / применять с

1 × CAMELEON CABLE E27

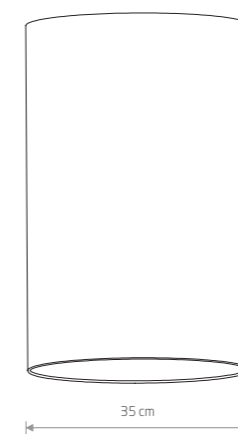

CAMELEON BARREL L

velvet

8507 8417 8510



works with / zastosuj z / применять с

1 × CAMELEON CABLE E27

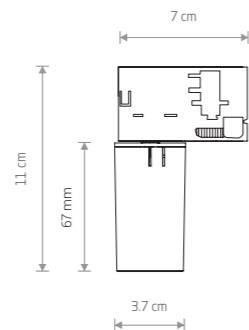

CAMELEON ADAPTER CTLS

plastic

■ 8281 ■ 8282

works with / zastosuj z / применять с

CTLS - 3 CIRCUITS TRACK LIGHT SYSTEM (COMMERCIAL LIGHTING)
 CTLS - 3 OBWODOWY SYSTEM SZYNOPRZEWODOWY (COMMERCIAL LIGHTING)
 CTLS - ТРЁХФАЗНАЯ ТРЕКОВАЯ СИСТЕМА (COMMERCIAL LIGHTING)



PDF COMMERCIAL LIGHTING



CAMELEON ADAPTER PROFILE
8360

CAMELEON CYLINDER M
8541

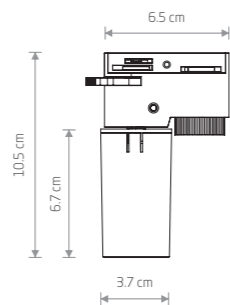

CAMELEON ADAPTER PROFILE

plastic

■ 8360 ■ 8361

works with / zastosuj z / применять с

PROFILE - 1 CIRCUIT TRACK LIGHT SYSTEM (CATALOGUE 2022)
 PROFILE - 1 OBWODOWY SYSTEM SZYNOPRZEWODOWY (CATALOGUE 2022)
 PROFILE - ОДНОФАЗНАЯ ТРЕКОВАЯ СИСТЕМА (CATALOGUE 2022)



PDF CATALOGUE 2022

CAMELEON CABLE E27 | max 40W

plastic, painted steel



■ BL

| LENGHT | ITEM NO. |
|--------|----------|
| 1,5 m | 8670 |
| 2,5 m | 8667 |
| 3,5 m | 8668 |
| 5 m | 8664 |
| 7 m | 8663 |

plastic, painted steel



■ WH

| LENGHT | ITEM NO. |
|--------|----------|
| 1,5 m | 8654 |
| 2,5 m | 8652 |
| 3,5 m | 8653 |
| 5 m | 8648 |
| 7 m | 8647 |

plastic, brass-plated steel



■ BL/BS

| LENGHT | ITEM NO. |
|--------|----------|
| 1,5 m | 8666 |
| 2,5 m | 8665 |
| 3,5 m | 8662 |
| 5 m | 8661 |
| 7 m | 8660 |

plastic, chrome plated steel



■ BL/CH

| LENGHT | ITEM NO. |
|--------|----------|
| 1,5 m | 8658 |
| 3,5 m | 8656 |
| 7 m | 8651 |

plastic, chrome plated steel



■ WH/CH

| LENGHT | ITEM NO. |
|--------|----------|
| 1,5 m | 8650 |
| 3,5 m | 8645 |

CAMELEON CABLE GU10 | max 10W only LED

plastic, chrome plated steel



■ BL/CH

| LENGHT | ITEM NO. |
|--------|----------|
| 1,5 m | 8635 |
| 2,5 m | 8633 |
| 3,5 m | 8641 |
| 5 m | 8630 |
| 7 m | 8628 |

plastic, chrome plated steel



■ WH/CH

| LENGHT | ITEM NO. |
|--------|----------|
| 1,5 m | 8620 |
| 2,5 m | 8617 |
| 5 m | 8614 |

CAMELEON CABLE G9 SB | max 10W only LED

plastic, painted steel



■ BL

| LENGHT | ITEM NO. |
|--------|----------|
| 1,5 m | 10337 |
| 3,5 m | 10340 |
| 5 m | 10342 |



■ WH

| LENGHT | ITEM NO. |
|--------|----------|
| 1,5 m | 10338 |
| 3,5 m | 10341 |
| 5 m | 10343 |

CAMELEON CABLE G9 | max 10W only LED

plastic, painted steel



■ BL

| LENGHT | ITEM NO. |
|--------|----------|
| 1,5 m | 8632 |
| 2,5 m | 8631 |
| 3,5 m | 8627 |
| 5 m | 8626 |
| 7 m | 8625 |

plastic, painted steel



■ WH

| LENGHT | ITEM NO. |
|--------|----------|
| 1,5 m | 8640 |
| 2,5 m | 8638 |
| 3,5 m | 8637 |
| 5 m | 8636 |
| 7 m | 8634 |

plastic, brass-plated steel



■ BL/BS

| LENGHT | ITEM NO. |
|--------|----------|
| 1,5 m | 8622 |
| 2,5 m | 8621 |
| 3,5 m | 8618 |
| 5 m | 8616 |
| 7 m | 8615 |

plastic, chrome plated steel



■ BL/CH

| LENGHT | ITEM NO. |
|--------|----------|
| 1,5 m | 8601 |
| 3,5 m | 8623 |
| 7 m | 8594 |

plastic, chrome plated steel



■ WH/CH

| LENGHT | ITEM NO. |
|--------|----------|
| 1,5 m | 8585 |
| 3,5 m | 8624 |

CAMELEON CABLE WITH SWITCH

plastic



■ 8611 ■ 8612

| LENGHT | ITEM NO. |
|--------|----------|
| 2 m | 8611 |
| 2 m | 8612 |

works with CANOPY A, CANOPY A MINI /
zastosuj z PUSZKA A, PUSZKA A MINI /
применять с ОСНОВАНИЕ А, ОСНОВАНИЕ А MINI

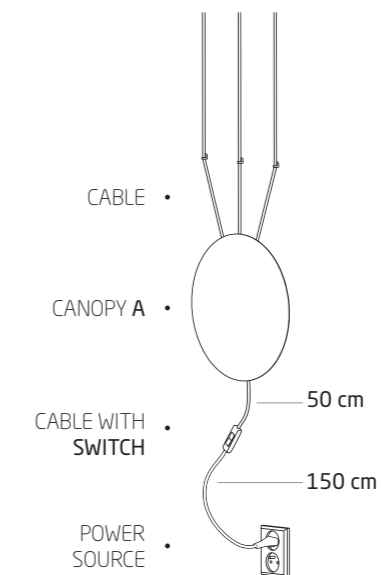

CAMELEON CANOPY

CAMELEON PUSZKA
CAMELEON ОСНОВАНИЕ

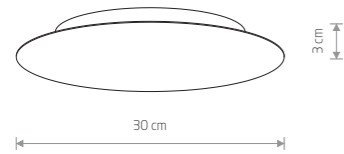

CAMELEON CANOPY A

painting: steel, plastic

works with / zastosuj z / применять с

max 12 lamps × max 40W

8565 8563

aluminum, plastic

works with / zastosuj z / применять с

max 12 lamps × max 40W

10336

application: wall / ceiling
zastosowanie: ściana / sufit
применение: стена / потолок

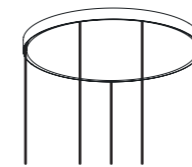
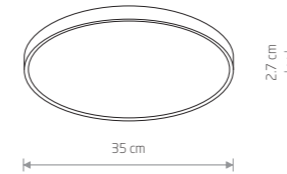

CAMELEON CANOPY H

painting: steel

works with / zastosuj z / применять с

max 12 lamps × max 40W

10275 10274

application: ceiling
zastosowanie: sufit
применение: потолок

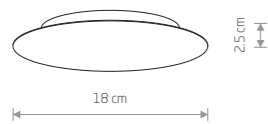

CAMELEON CANOPY A MINI

painting: steel, plastic

works with / zastosuj z / применять с

max 4 lamps × max 40W

10017 10018

aluminum, plastic

works with / zastosuj z / применять с

max 4 lamps × max 40W

10264

application: wall / ceiling
zastosowanie: ściana / sufit
применение: стена / потолок

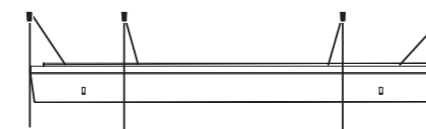
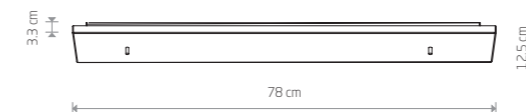

CAMELEON CANOPY D 780

painting: steel

works with / zastosuj z / применять с

max 12 lamps × max 40W

8553 8552

application: ceiling
zastosowanie: sufit
применение: потолок

CAMELEON CANOPY

CAMELEON PUSZKA
CAMELEON ОСНОВАНИЕ

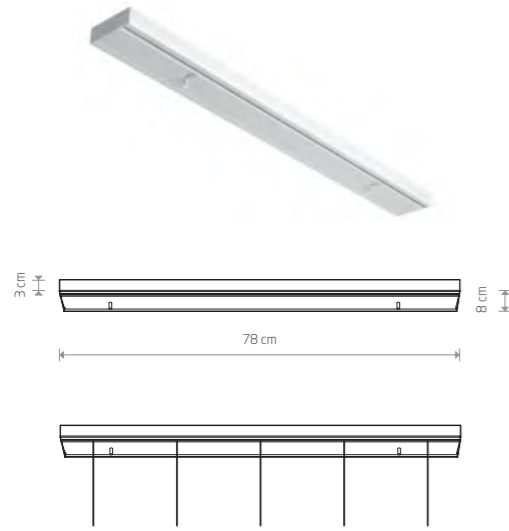

CAMELEON CANOPY B 780

■ painted steel

works with / zastosuj z / применять с

💡 max 12 lamps × max 40W □

■ 8562 ■ 8561

application: ceiling
zastosowanie: sufit
применение: потолок

CAMELEON CANOPY

CAMELEON PUSZKA
CAMELEON ОСНОВАНИЕ



CAMELEON CANOPY C 780

■ painted steel

works with / zastosuj z / применять с

💡 max 12 lamps × max 40W □

■ 8557 ■ 8556

application: ceiling
zastosowanie: sufit
применение: потолок



CAMELEON CANOPY B 1500

■ painted steel

works with / zastosuj z / применять с

💡 max 12 lamps × max 40W □

■ 8560 ■ 8558

application: ceiling
zastosowanie: sufit
применение: потолок

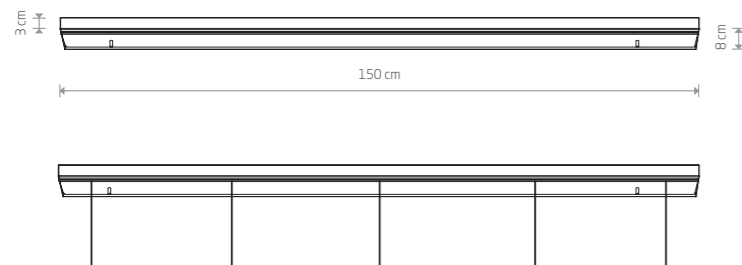

CAMELEON CANOPY C 1200

■ painted steel

works with / zastosuj z / применять с

💡 max 12 lamps × max 40W □

■ 8555 ■ 8554

application: ceiling
zastosowanie: sufit
применение: потолок

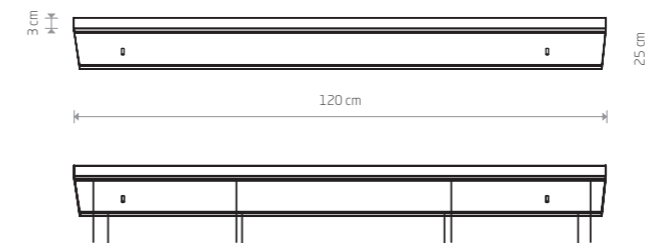

CAMELEON CANOPY

CAMELEON PUSZKA
CAMELEON ОСНОВАНИЕ

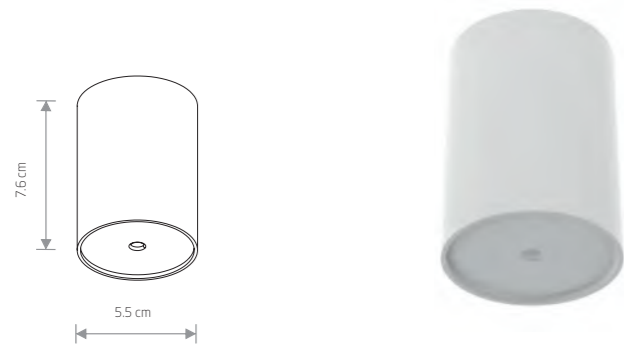

CAMELEON CANOPY E

painted steel

works with / zastosuj z / применять с

max 1 lamps × max 40W

8551 8550

application: ceiling
zastosowanie: sufit
применение: потолок

CAMELEON CANOPY

CAMELEON PUSZKA
CAMELEON ОСНОВАНИЕ

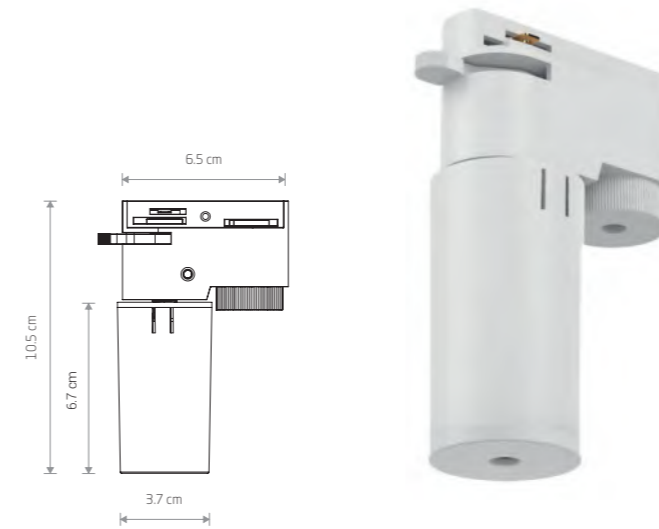

CAMELEON ADAPTER PROFILE

plastic

works with / zastosuj z / применять с

max 1 lamps × max 40W

8361 8360

works with / zastosuj z / применять с

PROFILE - 1 CIRCUIT PROFILE TRACK LIGHT SYSTEM
PROFILE - 1 OBWODOWY SYSTEM SZYNOPRZEWODOWY
PROFILE - ОДНОФАЗНАЯ ТРЕКОВАЯ СИСТЕМА

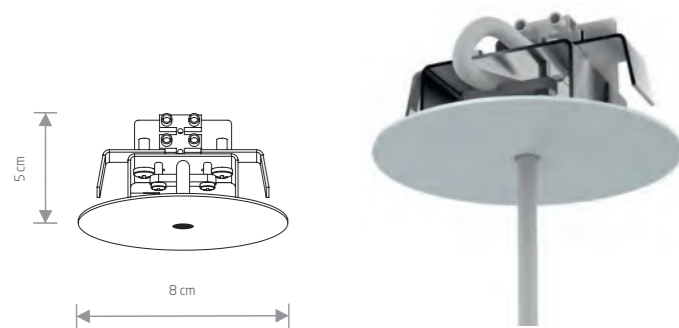

CAMELEON CANOPY F

painted steel

works with / zastosuj z / применять с

max 1 lamps × max 40W

8548 8547

application: ceiling
zastosowanie: sufit
применение: потолок

cut out \varnothing 58 mm

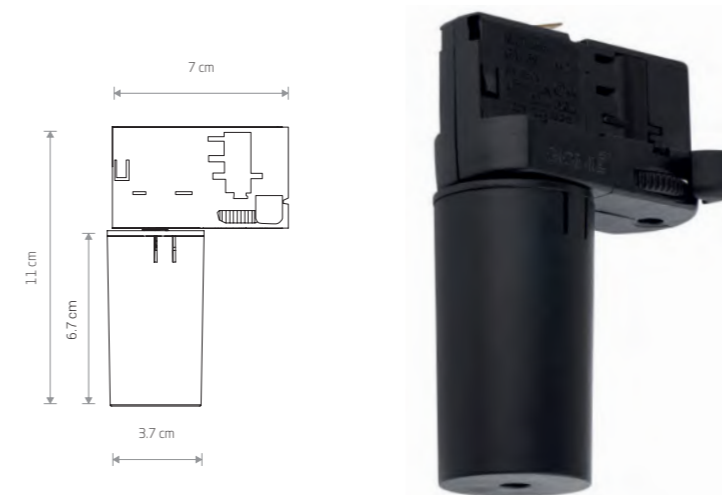

CAMELEON ADAPTER CTLS

plastic

works with / zastosuj z / применять с

max 1 lamps × max 40W

8282 8281

works with / zastosuj z / применять с

CTLS - 3 CIRCUITS TRACK LIGHT SYSTEM
CTLS - 3 OBWODOWY SYSTEM SZYNOPRZEWODOWY
CTLS - ТРЁХФАЗНАЯ ТРЕКОВАЯ СИСТЕМА

CAMELEON FIXING

CAMELEON AKCESORIA MONTAŻOWE
CAMELEON AKCEССУАРЫ ДЛЯ КРЕПЛЕНИЯ

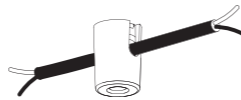
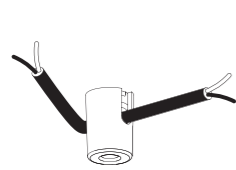
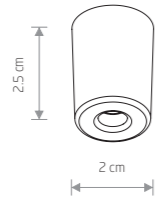

CAMELEON MOUNTING A

plastic

8396 8395

application: wall / ceiling
zastosowanie: ściana / sufit
применение: стена / потолок

allows the change of wire direction
umożliwia zmianę kierunku przebiegu przewodu
позволяет менять направления кабеля

CAMELEON MOUNTING A
CAMELEON MOUNTING A - included (3pcs). Mounting screws are not included /
Zestaw zawiera 3 sztuki elementu CAMELEON MOUNTING A. Zestaw nie zawiera wkrętów montażowych /
CAMELEON MOUNTING A - включено (3 шт.). Монтажные винты не включены

CAMELEON FIXING

CAMELEON AKCESORIA MONTAŻOWE
CAMELEON AKCEССУАРЫ ДЛЯ КРЕПЛЕНИЯ

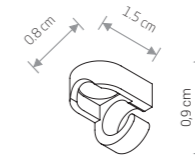

CAMELEON MOUNTING B

plastic

8394 8393

application: ceiling
zastosowanie: sufit
применение: потолок

prevents wire from sagging
zapobiega obwisaniu przewodu
предотвращает провисание кабеля

CAMELEON MOUNTING B
CAMELEON MOUNTING B included (5pcs). Mounting screws are included (5pcs) /
Zestaw zawiera 5 sztuk elementu CAMELEON MOUNTING B. Zestaw zawiera 5 sztuk wkrętów montażowych /
CAMELEON MOUNTING B - включено (5 шт.). Монтажные винты включены (5 шт.)

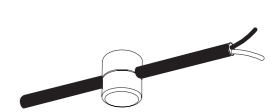
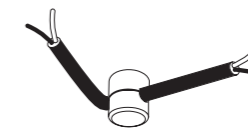
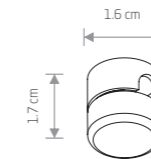

CAMELEON MOUNTING C

solid brass

8405

painting steel

7318 7320

application: wall / ceiling
zastosowanie: ściana / sufit
применение: стена / потолок

prevents wire from sagging
zapobiega obwisaniu przewodu
предотвращает провисание кабеля

CAMELEON MOUNTING C
CAMELEON MOUNTING C - included (5pcs). Mounting screws - not included /
Zestaw zawiera 5 sztuk elementu CAMELEON MOUNTING C. Zestaw nie zawiera wkrętów montażowych /
CAMELEON MOUNTING C - включено (5 шт.). Монтажные винты не включены

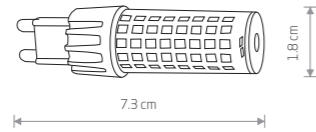

BULB LED G9, 7W

ceramic housing, plastic PC

9197 3000K

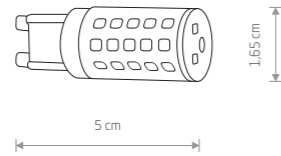

BULB LED G9, 4W

plastic PC

7503 3000K 7504 4000K

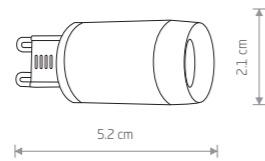

BULB LENS LED, G9, 3W

ceramic housing, plastic PC

9173 3000K 8447 4000K

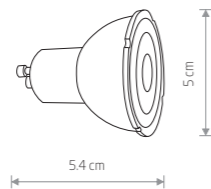

REFLECTOR LED, GU10, R50, 7W

plastic

9180 3000K 8348 3000K
9178 4000K 8347 4000K

| Item No. | Power | Colour temp. | Luminous flux | Beam angle | Colour Rendering Index (CRI) | Input | Power factor | Lifetime |
|----------|--------|--------------|---------------|------------|------------------------------|----------------------|--------------|----------|
| 9197 | 7W LED | 3000K | 750 lm | 360° | ≥ 80 | ~220-230 V, 50/60 Hz | >0.5 | 25000h |
| 7503 | 4W LED | 3000K | 380 lm | 360° | ≥ 80 | ~220-230 V, 50/60 Hz | >0.4 | 25000h |
| 7504 | 4W LED | 4000K | 390 lm | 360° | ≥ 80 | ~220-230 V, 50/60 Hz | >0.4 | 25000h |
| 9173 | 3W LED | 3000K | 330 lm | 90° | ≥ 80 | ~220-230 V, 50/60 Hz | >0.5 | 25000h |
| 8447 | 3W LED | 4000K | 310 lm | 90° | >80 | ~220-230 V, 50/60 Hz | >0.5 | 25000h |
| 9180 | 7W LED | 3000K | 600 lm | 39° | ≥ 80 | ~220-230 V, 50/60 Hz | >0.5 | 25000h |
| 9178 | 7W LED | 4000K | 620 lm | 50° | ≥ 80 | ~220-230 V, 50/60 Hz | >0.5 | 25000h |
| 8348 | 7W LED | 3000K | 560 lm | 41° | ≥ 80 | ~220-230 V, 50/60 Hz | >0.5 | 25000h |
| 8347 | 7W LED | 4000K | 570 lm | 40° | ≥ 80 | ~220-230 V, 50/60 Hz | >0.5 | 25000h |

WHITE BLACK

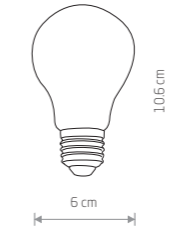

BULB VINTAGE LED E27, 4W

glass

9794

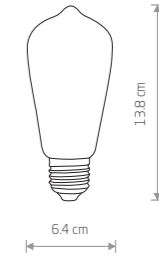

BULB VINTAGE LED E27, 4W

glass

9796

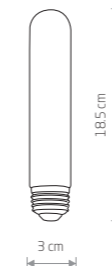

BULB VINTAGE LED E27, 4W

glass

9795



BULB VINTAGE LED E27, 4W

glass

9797

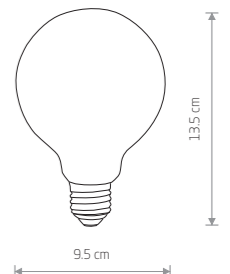

BULB GLASS BALL LED, E27, 8W

glass

9177

| Item No. | Power | Colour temp. | Luminous flux | Beam angle | Colour Rendering Index (CRI) | Input | Replacement | Switch cycles on/off | Lifetime |
|----------|--------|--------------|---------------|------------|------------------------------|----------------------|-------------|----------------------|----------|
| 9794 | 4W LED | 2200K | 400 lm | 360° | ≥ 80 | ~220-230 V, 50/60 Hz | 4W LED=35W | x15 000 | 15000h |
| 9796 | 4W LED | 2200K | 360 lm | 360° | ≥ 80 | ~220-230 V, 50/60 Hz | 4W LED=35W | x15 000 | 15000h |
| 9795 | 4W LED | 2200K | 370 lm | 360° | ≥ 80 | ~220-230 V, 50/60 Hz | 4W LED=35W | x15 000 | 15000h |
| 9797 | 4W LED | 2200K | 390 lm | 360° | ≥ 80 | ~220-230 V, 50/60 Hz | 4W LED=35W | x15 000 | 15000h |
| 9177 | 8W LED | 3000K | 840 lm | 360° | ≥ 80 | ~220-230 V, 50/60 Hz | 8W LED=60W | x15 000 | 25000h |

CAMELEON POSSIBILITIES

CANOPY A

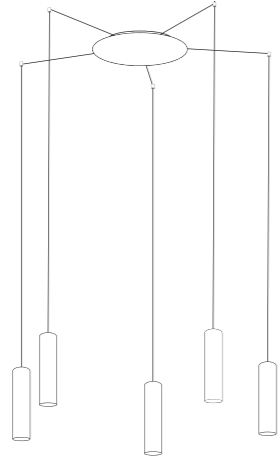

CANOPY A MINI

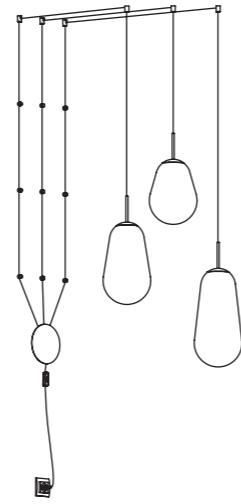

CANOPY H

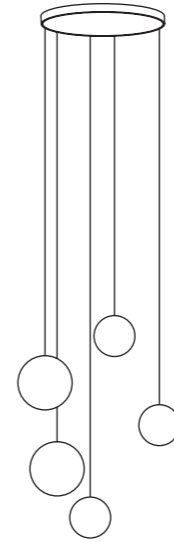

CANOPY D

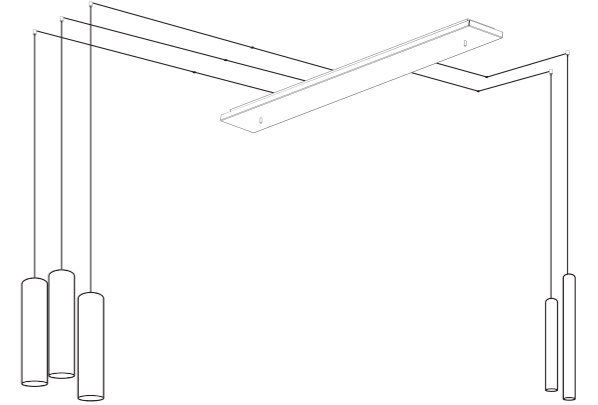

CANOPY B 780

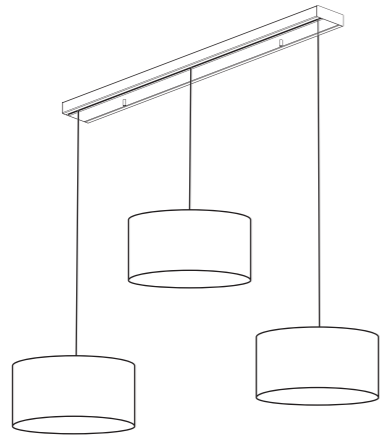

CANOPY C 780

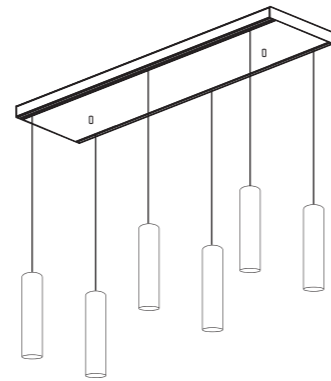

ADAPTER PROFILE

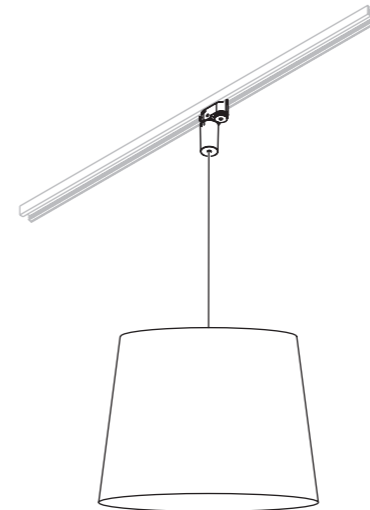

ADAPTER CTLS



CANOPY E

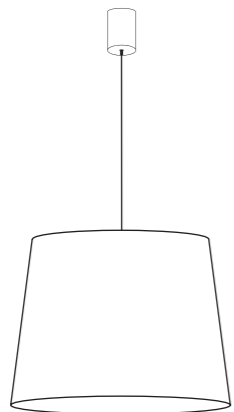

CANOPY F

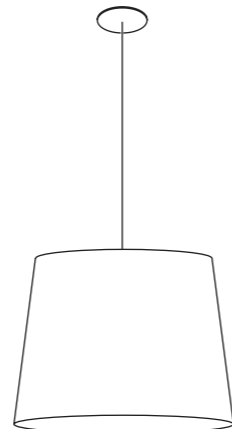

CANOPY A

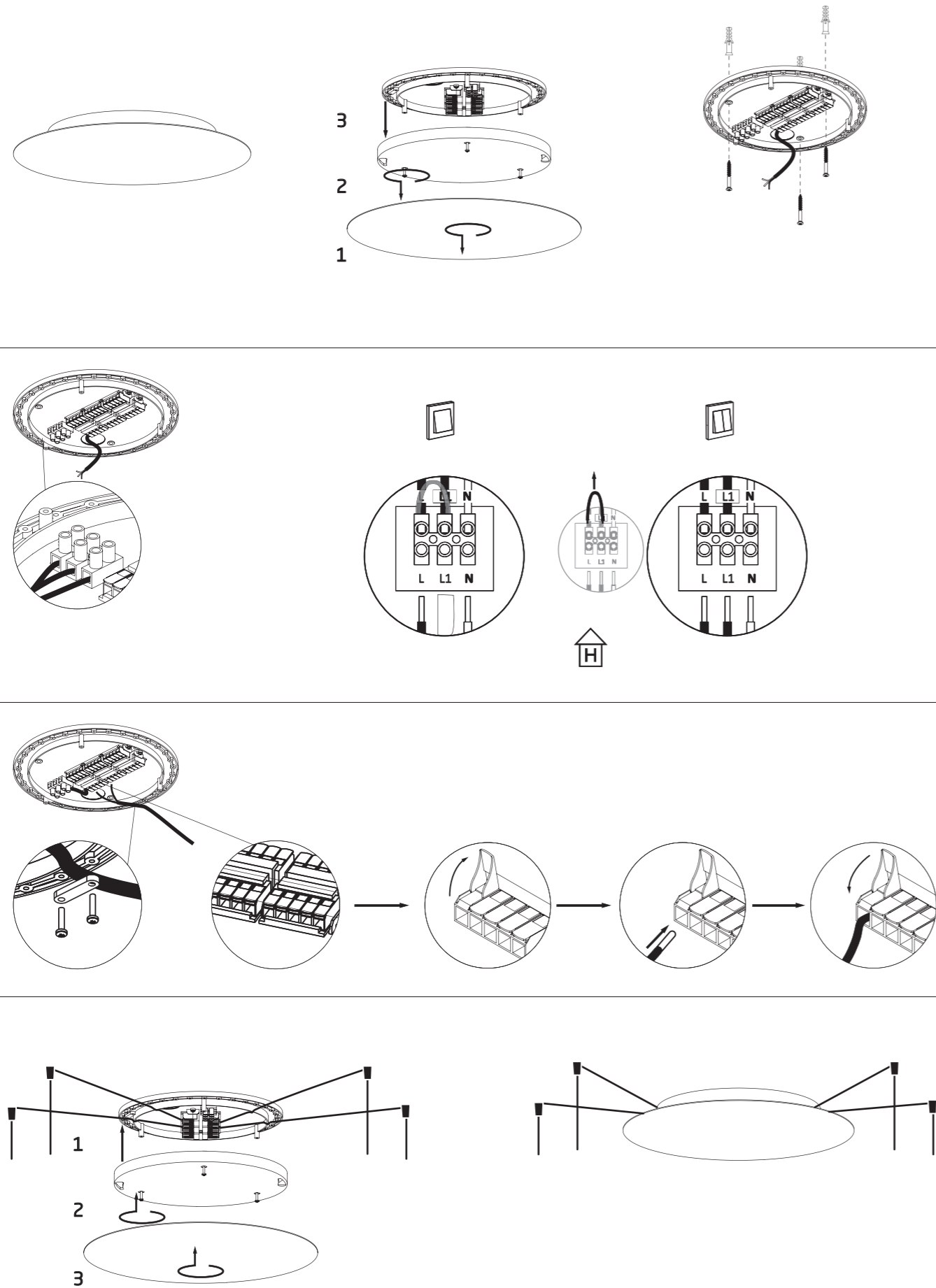

ZONES CANOPY A

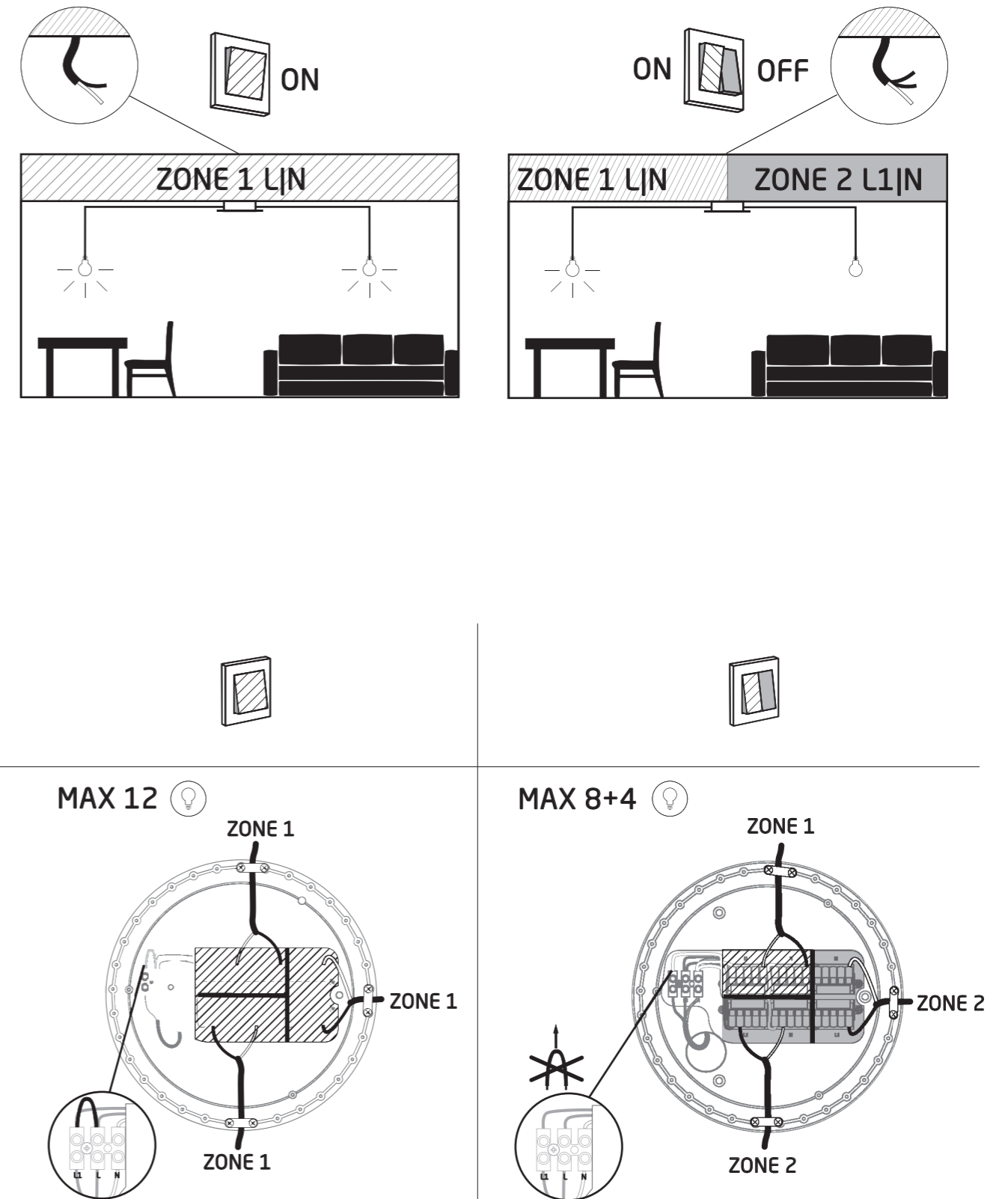

CANOPY H

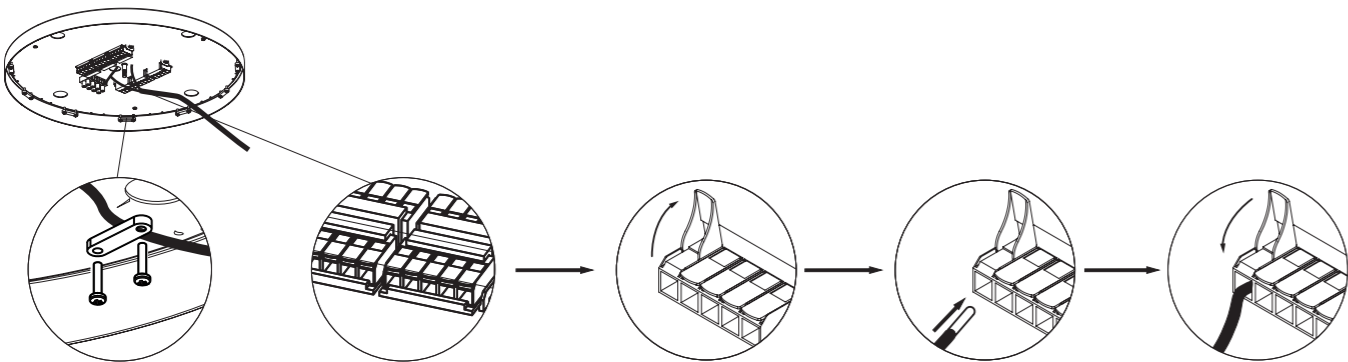
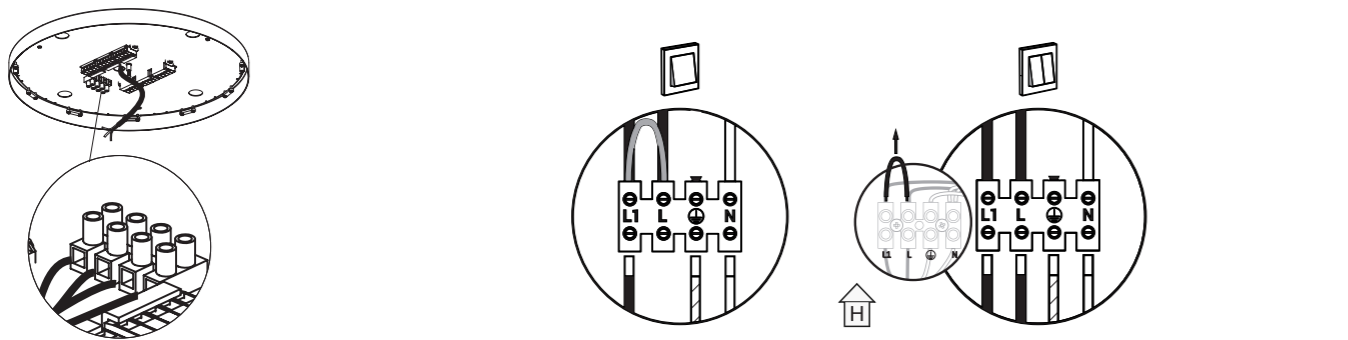
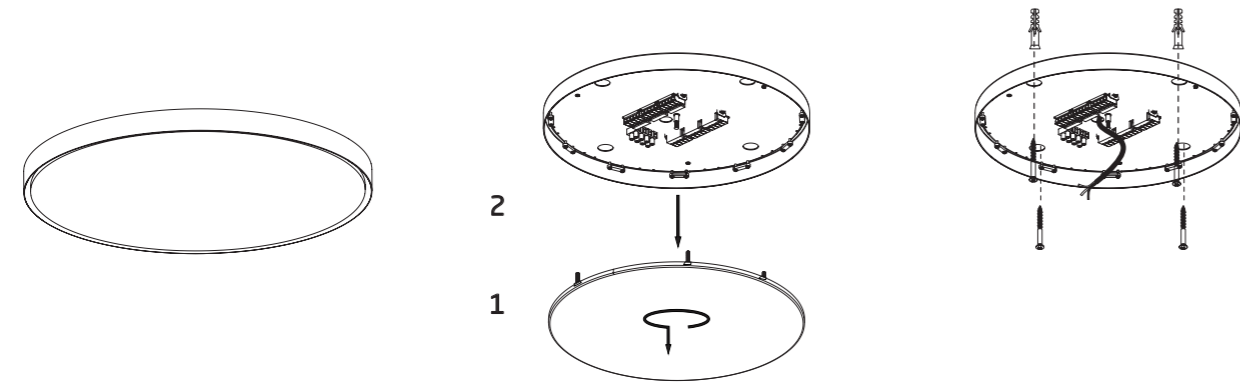

ZONES CANOPY H

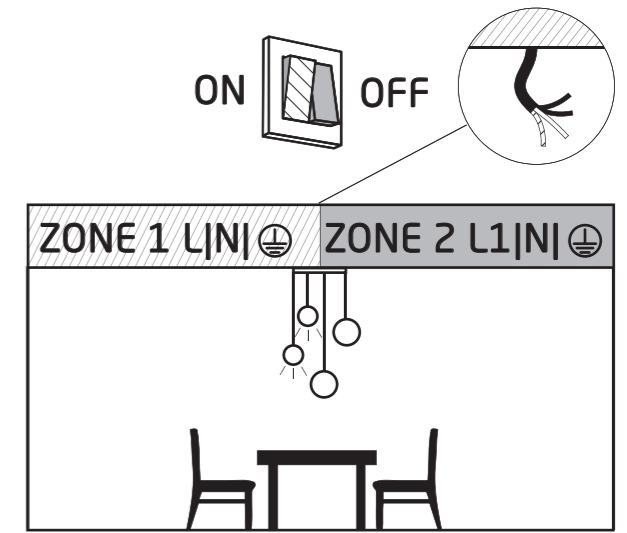
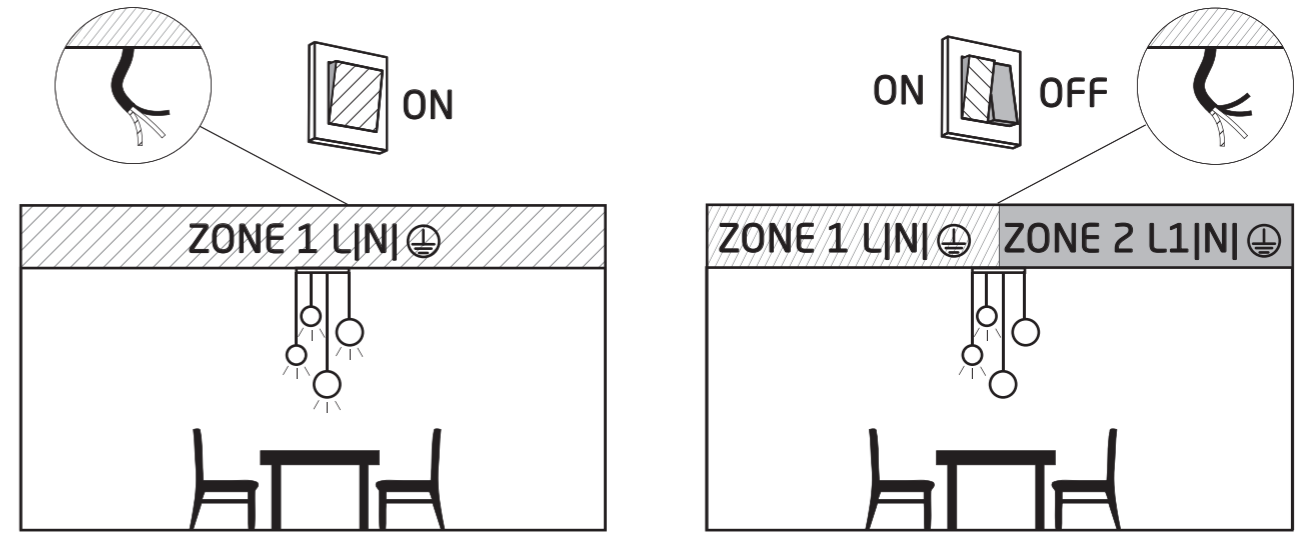

MAX 12

MAX 8+4

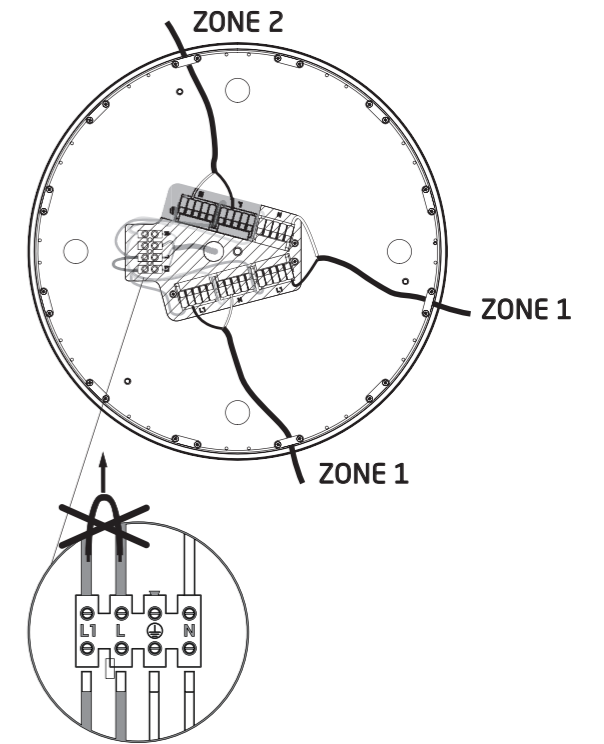
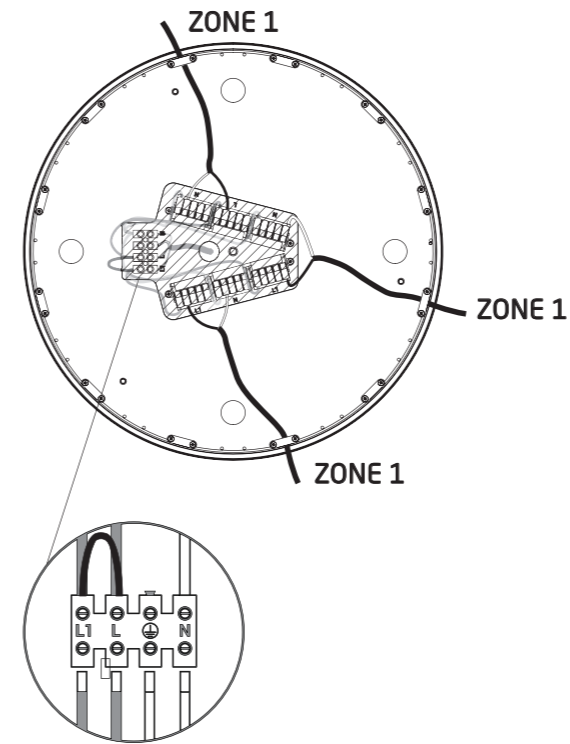

CANOPY B, C, D

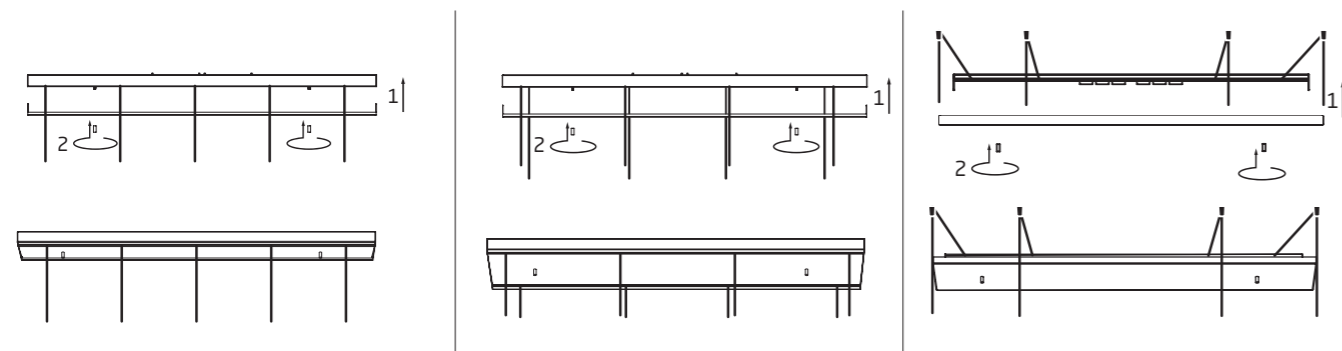
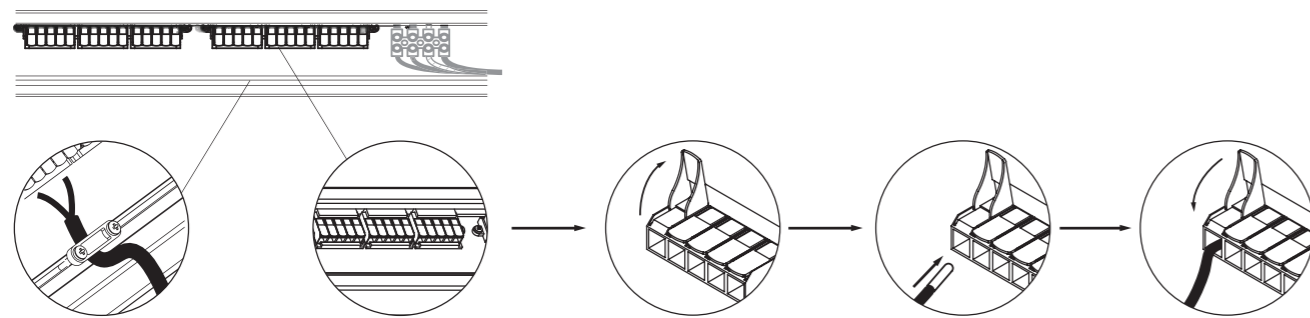
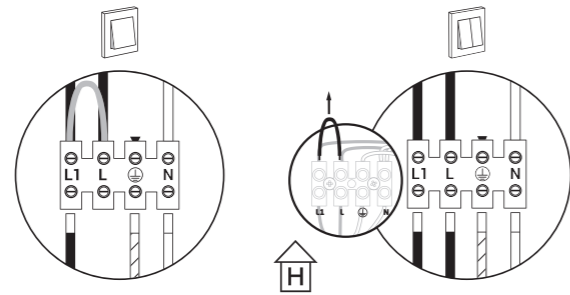
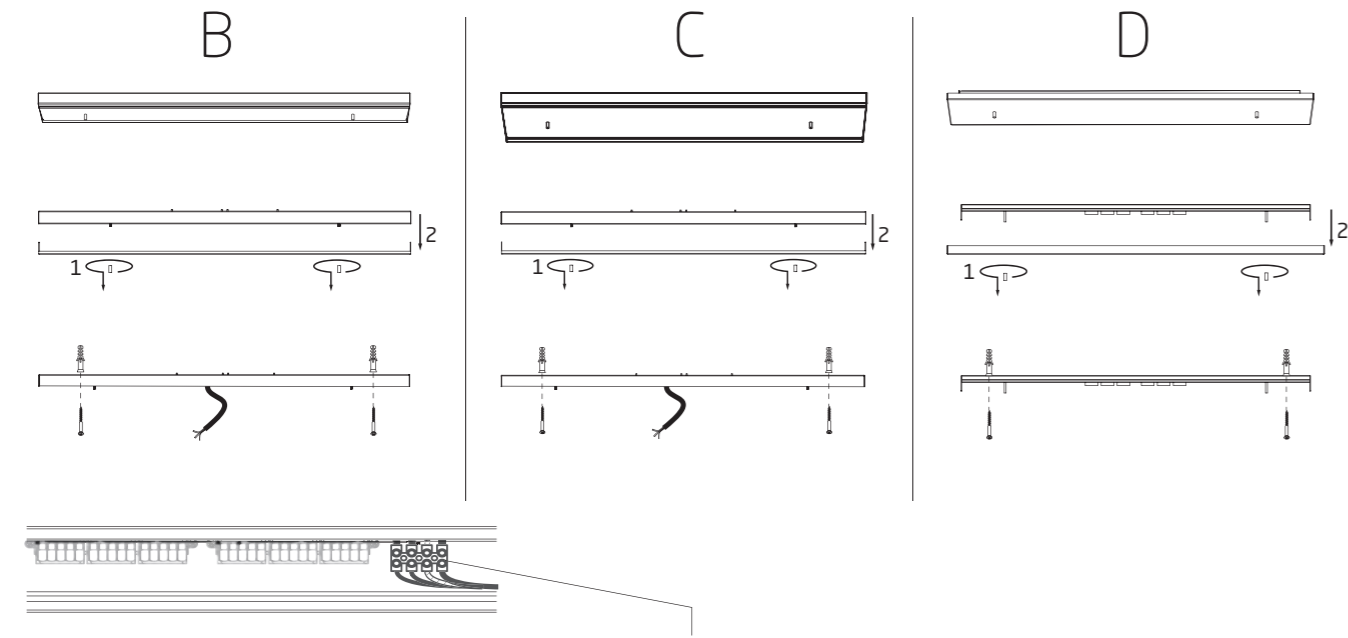

ZONES CANOPY B, C, D

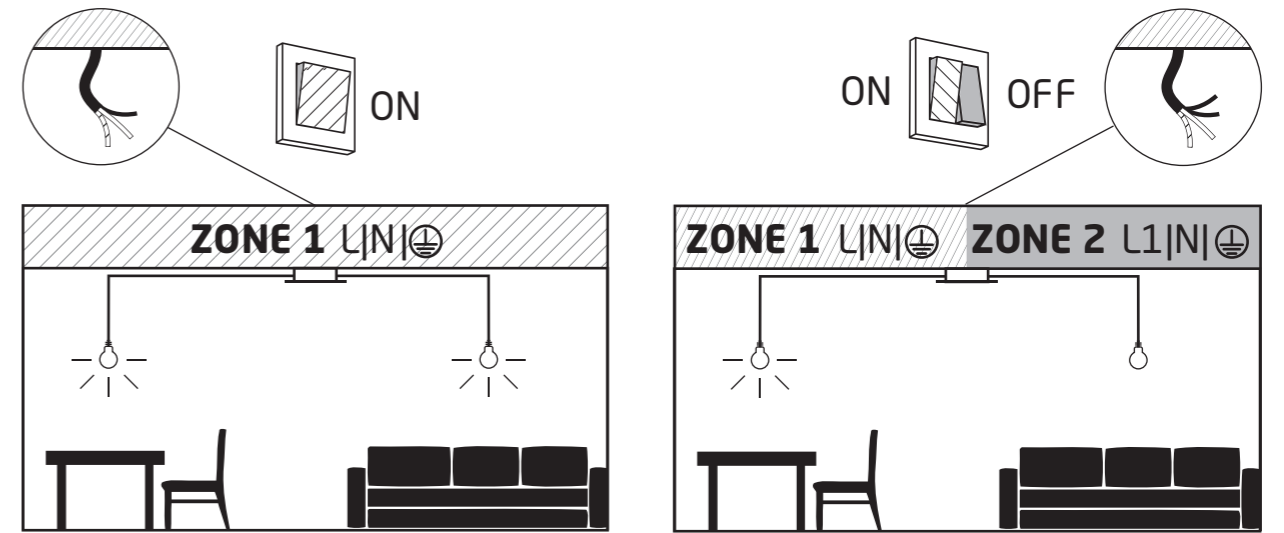

MAX 12

MAX 8+4

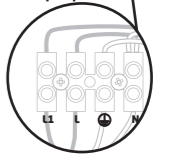
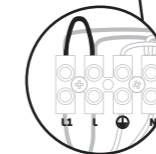
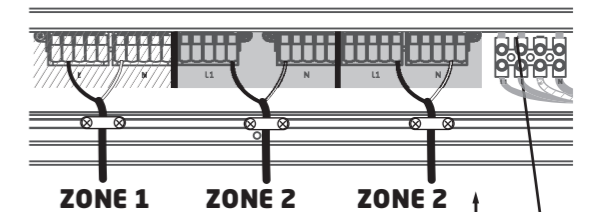
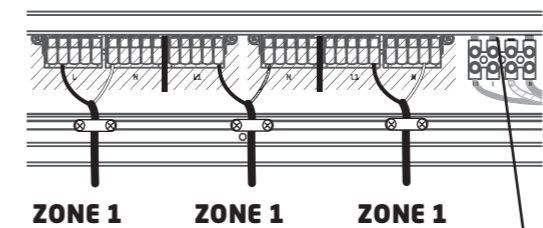

CANOPY E

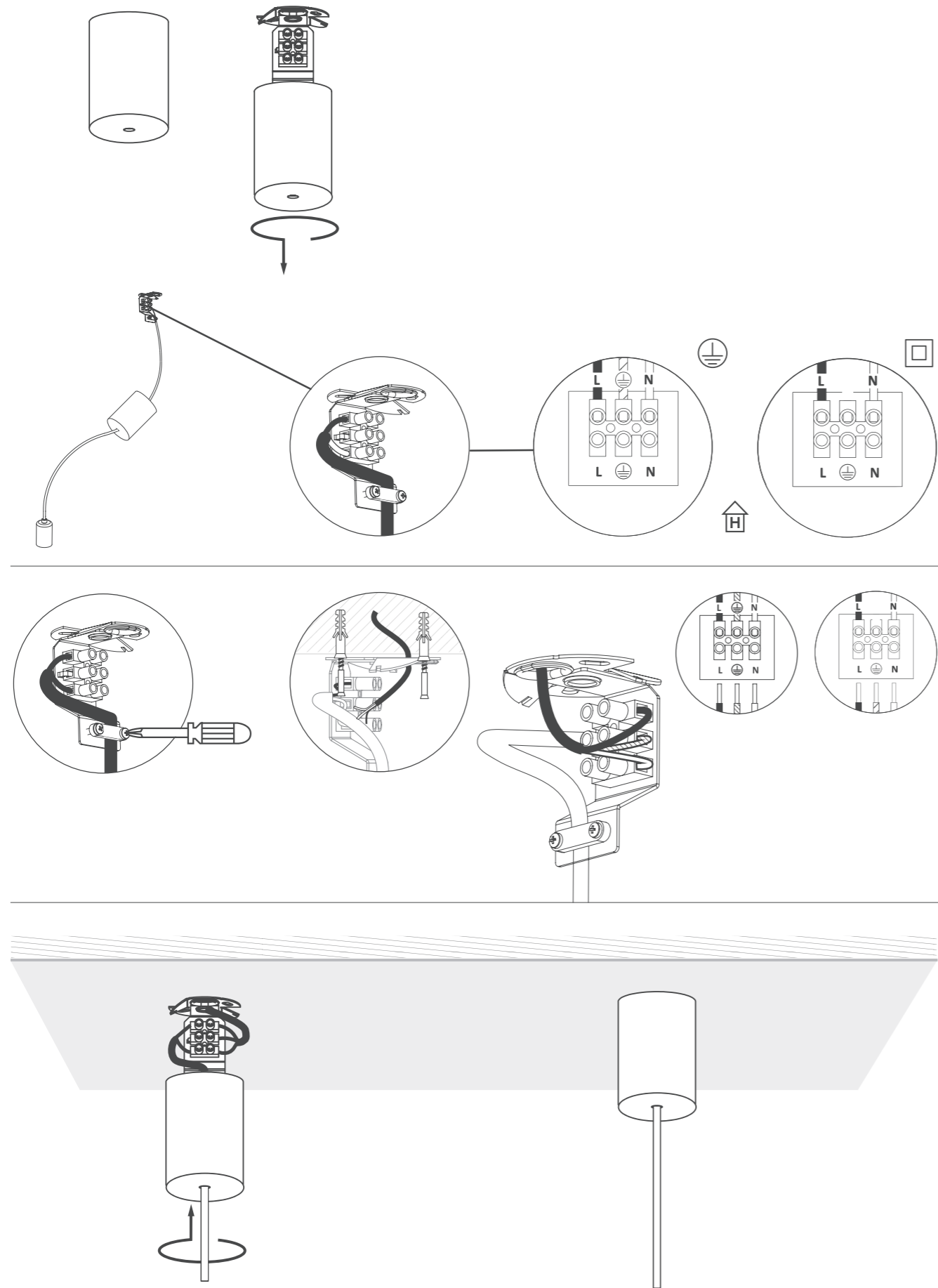

CANOPY F

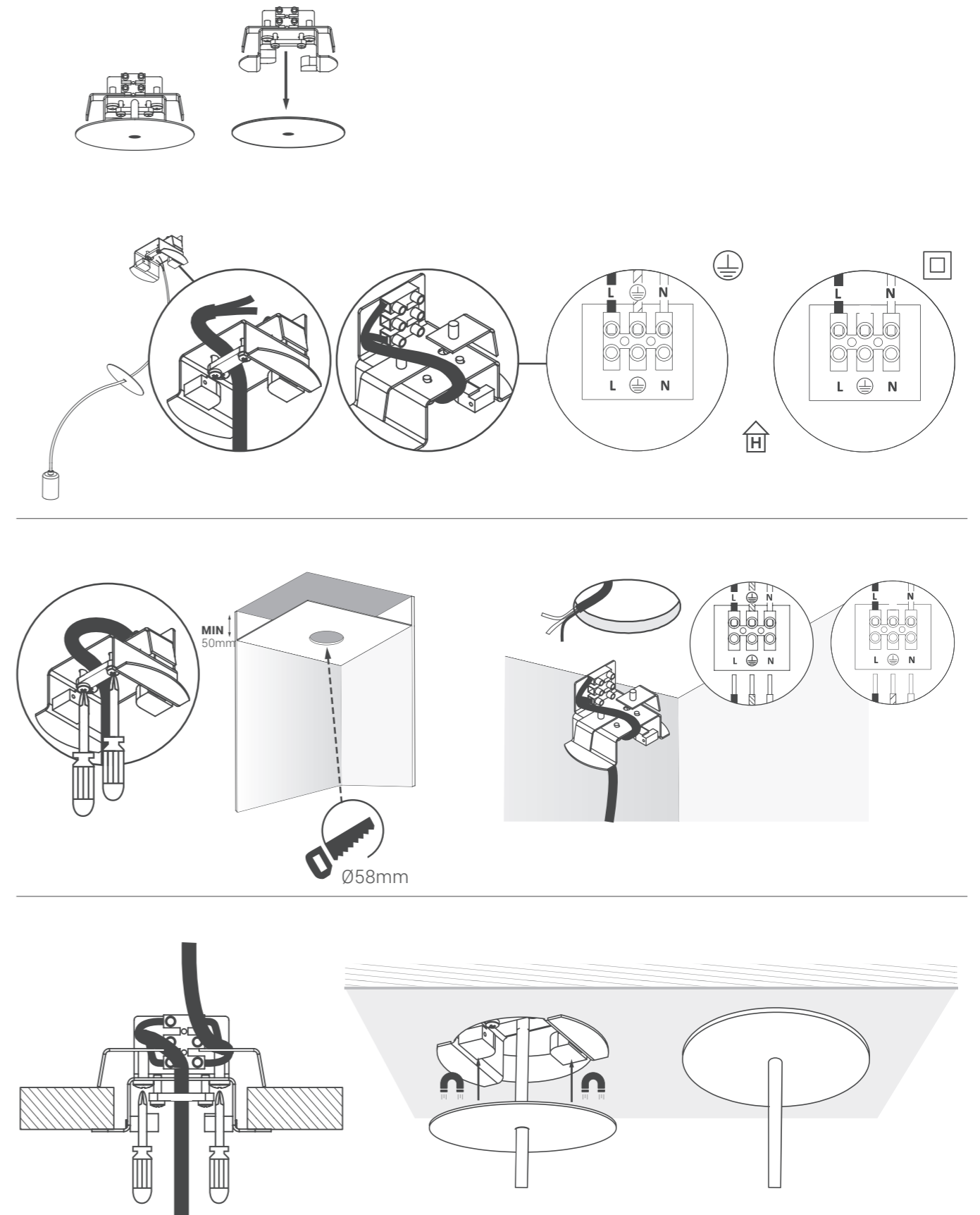

ADAPTER PROFILE

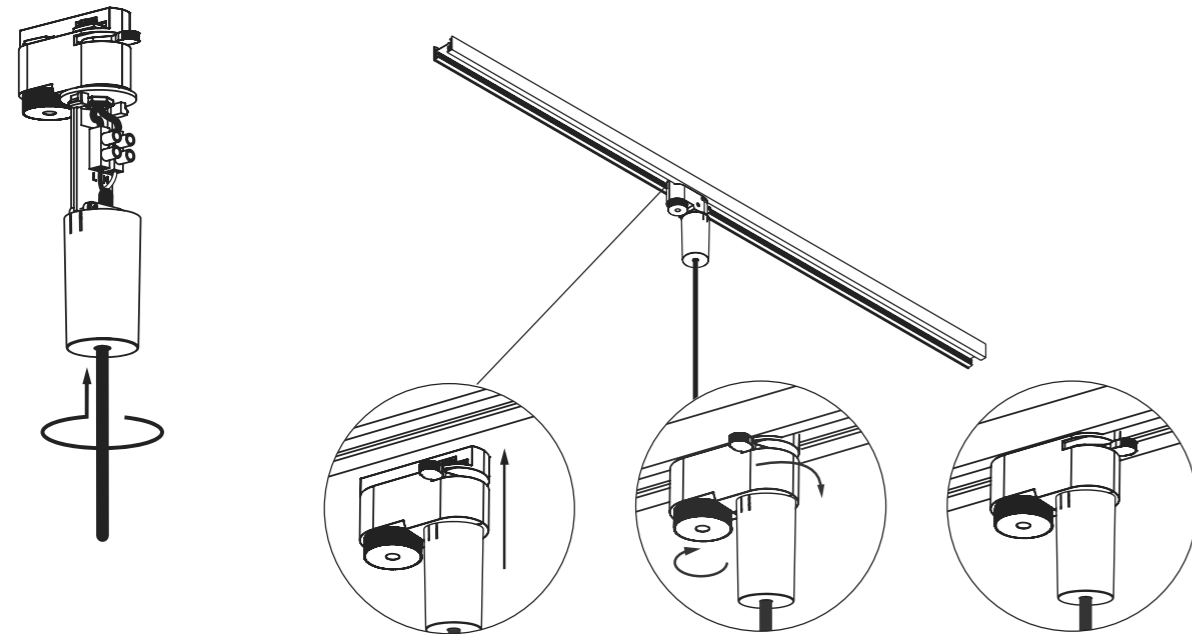
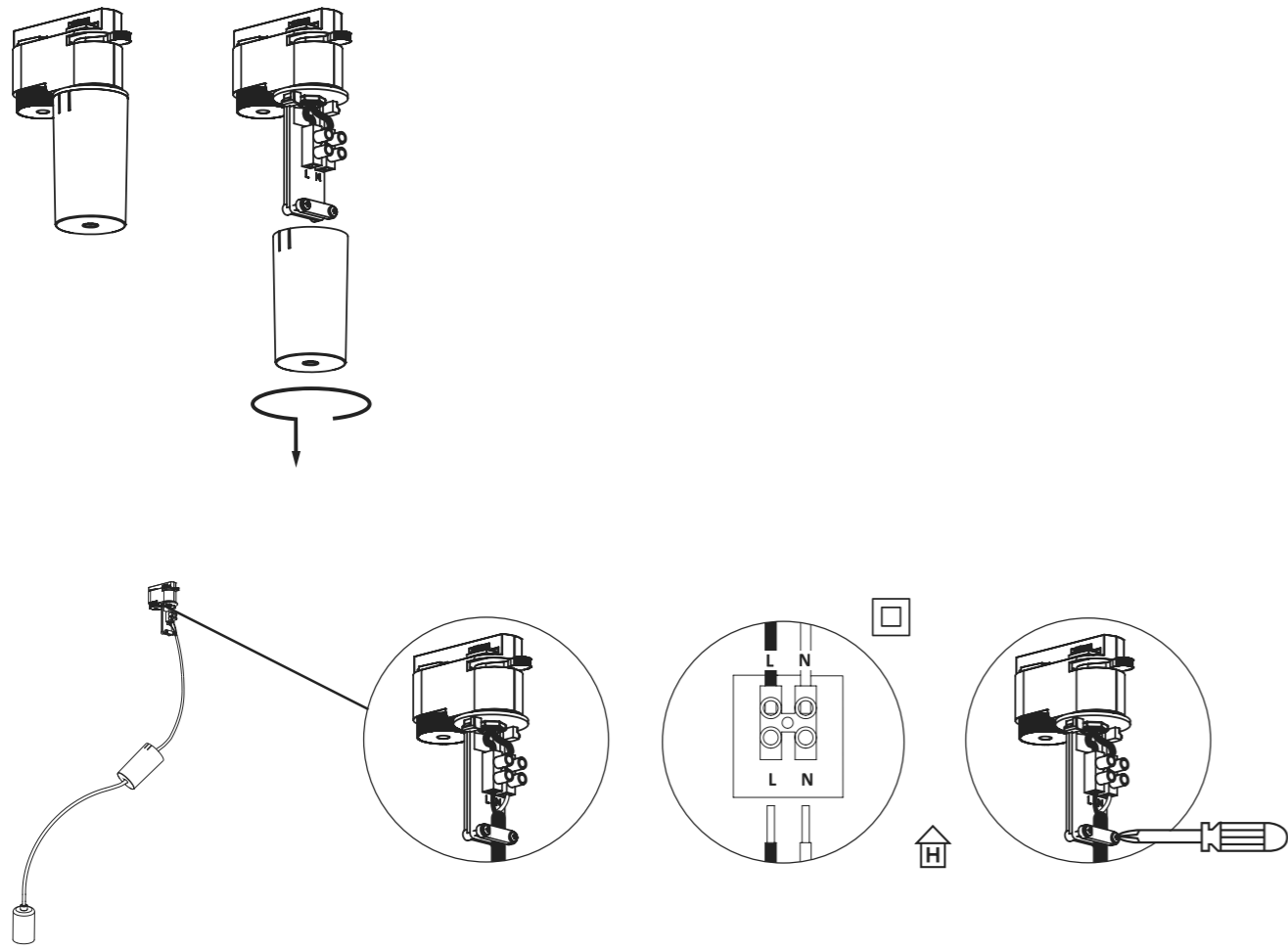

ADAPTER CTLS

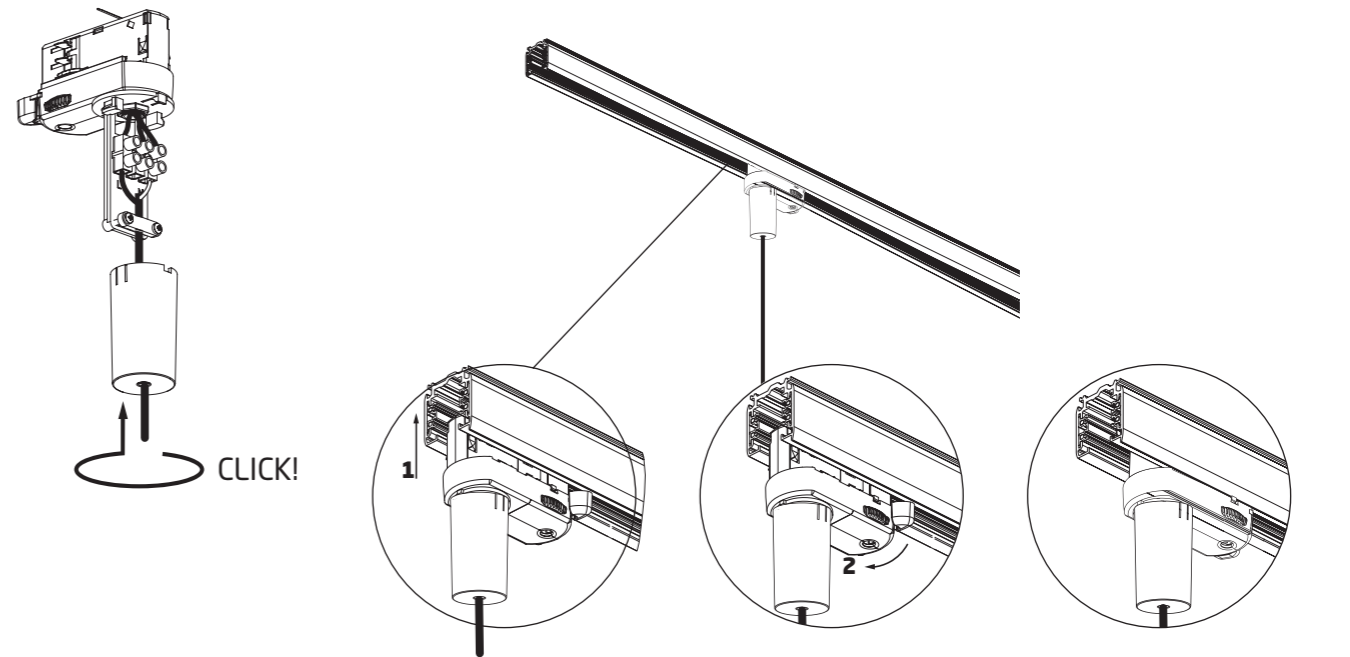
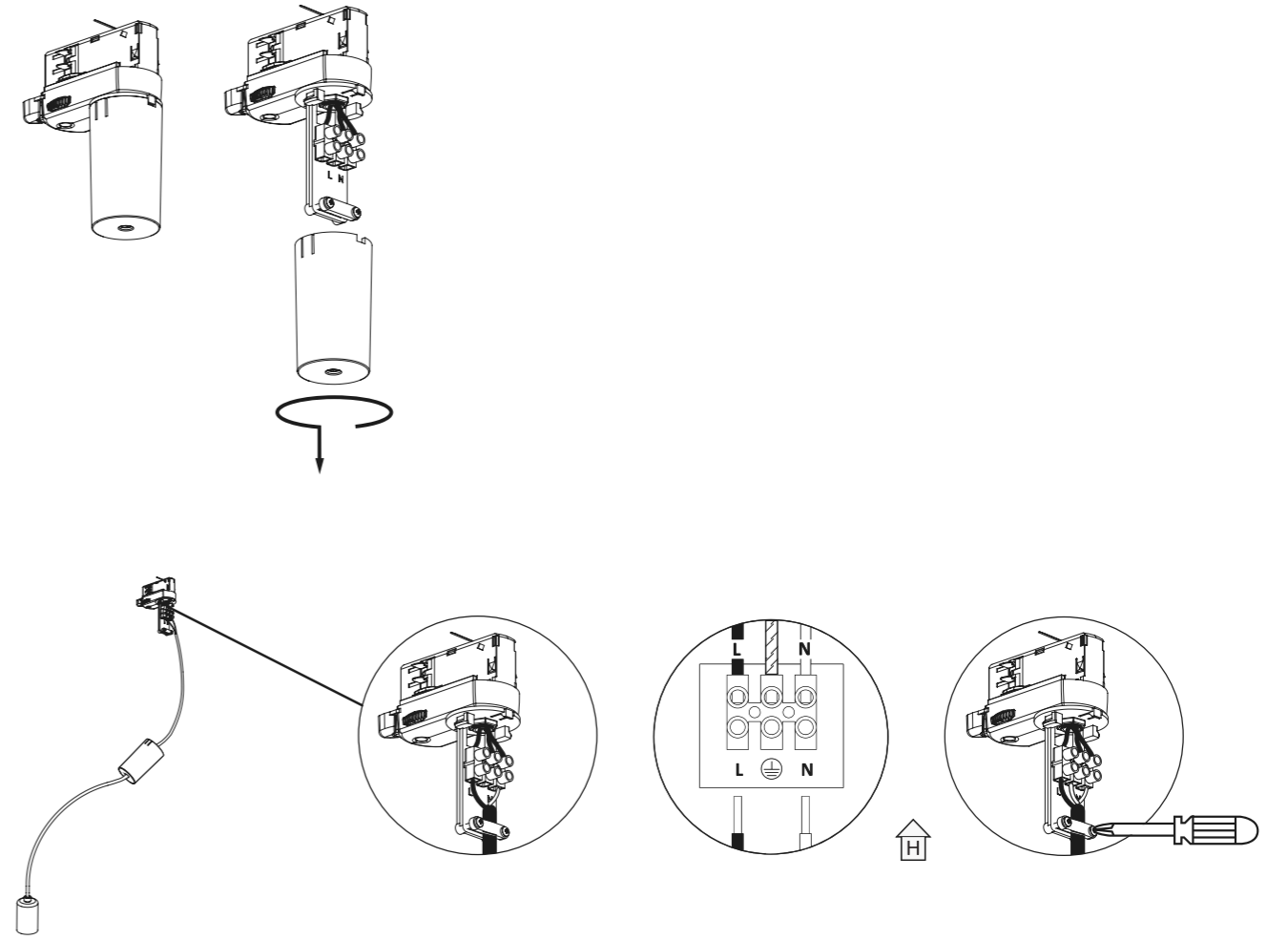

CANOPY A MINI

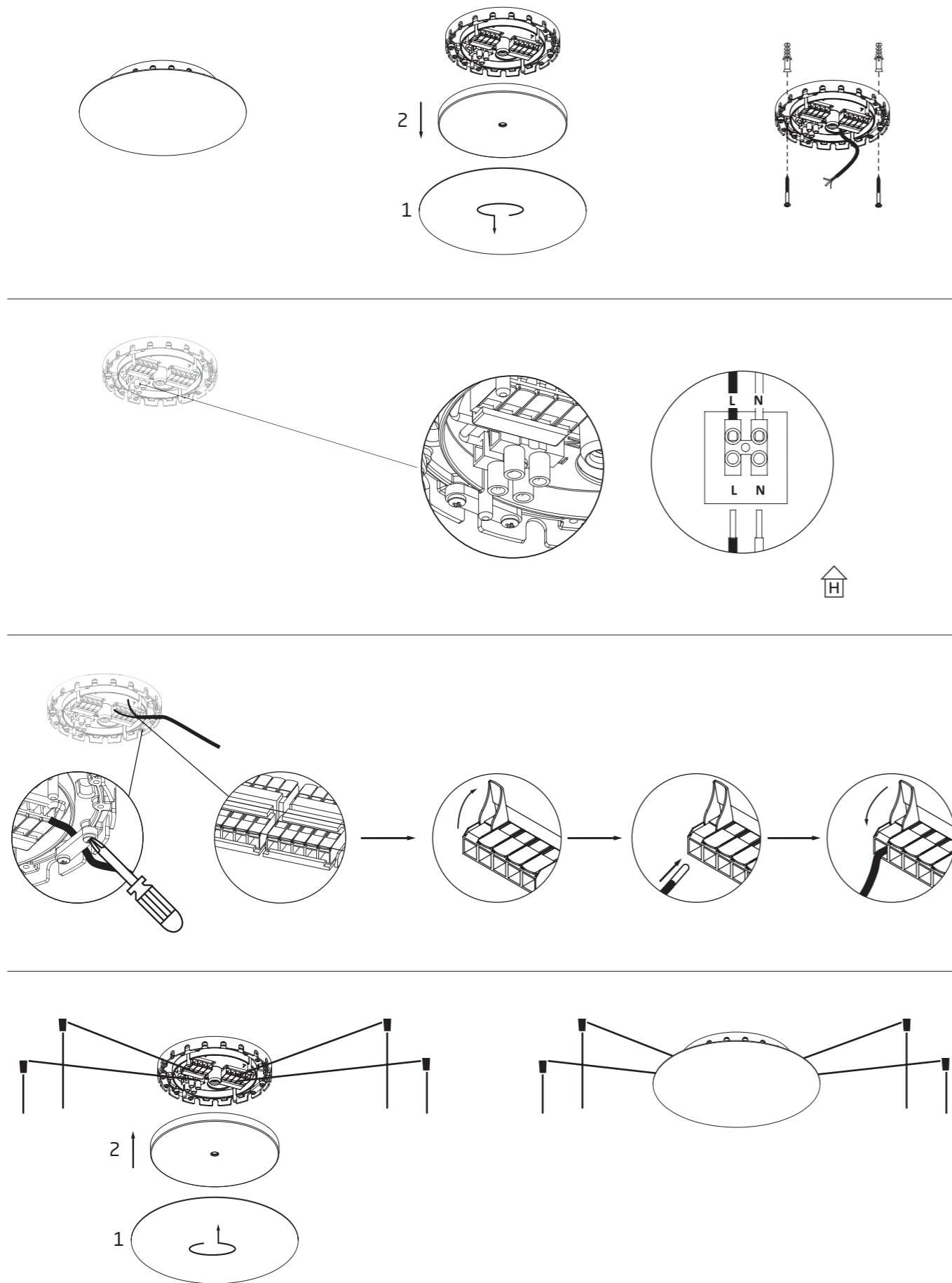

MOUNTING A, B, C

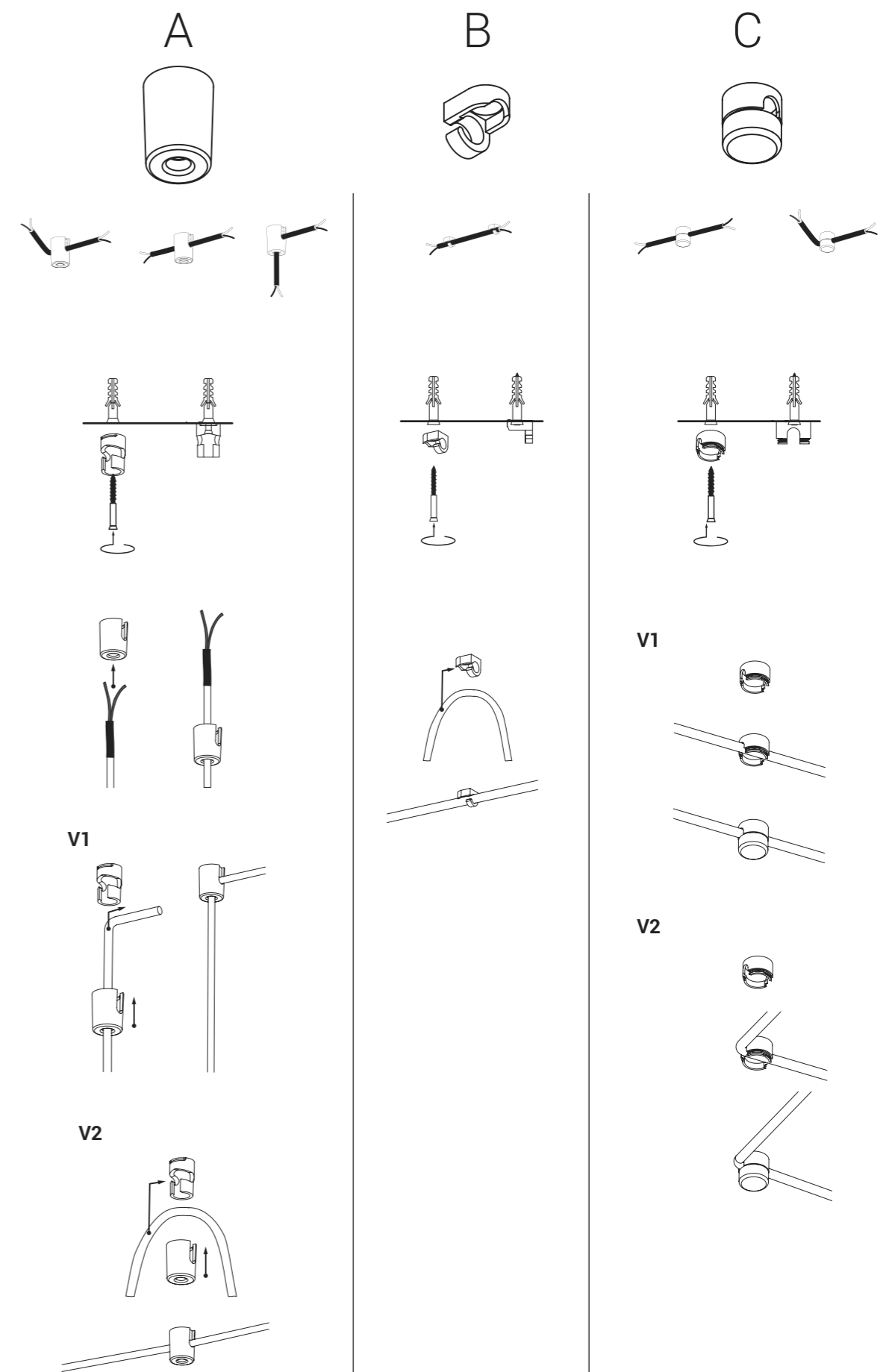

Informacje ogólne / General information / Главная Информация

Rzeczywiste parametry produktów mogą się różnić od wartości deklarowanych w katalogu o +/- 10%.
 The actual product parameters may differ from the values declared in the catalogue by +/- 10%.
 Фактические параметры товаров могут отличаться от заявленных в каталоге значений на +/- 10%.

Zdjęcia prezentowanego asortymentu w niniejszym katalogu mają charakter poglądowy.
 Rzeczywisty kolor produktów może nieznacznie odbiegać od prezentowanego na zdjęciach, ze względu na technologię druku.

Photos in this catalogue are for illustrative purposes only.
 The actual color of the products may slightly differ from that shown in the photos, due to the printing technology.

Фотографии представленного ассортимента в этом каталоге в качестве иллюстрации.
 Фактический цвет продуктов может незначительно отличаться от представленного на фотографиях из-за технологии печати.

Informacje techniczne / Technical information / Техническая информация

Temperatura barwowa (K) - w potocznym rozumieniu, to „kolor” światła białego emitowanego przez źródło, np. źródło LED.
 W uproszczeniu możemy podzielić je na światło o:

- barwie ciepłej
- barwie neutralnej
- barwie zimnej

Colour temperature (K) in common understanding is the colour of white light emitted by a source, for example such as an LED source.

In simple terms, we can divide them into:

- Warm white
- White
- Cool white

Цветовая температура (K) в общепринятом понимании - это «цвет» белого света, излучаемого источником, например светодиодом.

Проще говоря, мы можем разделить их на:

- Теплый белый
- Белый
- Холодный белый

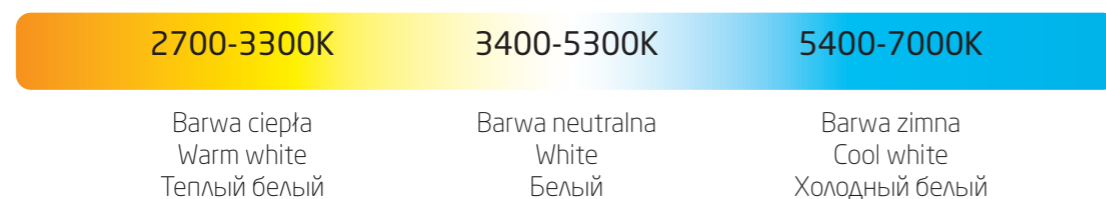

Strumień świetlny (lm/lumen) - w potocznym rozumieniu, to całkowita moc światła emitowanego z danego źródła światła.

Lumen (lm) - jednostka miary strumienia świetlnego w układzie SI

1 lm = 1 cd·sr

Luminous flux (lm / lumen) - the total power of light emitted from a light source.

Lumen (symbol: lm) - the unit of luminous flux in SI system.

1 lm = 1 cd·sr

Световой поток (лм / люмен) - общая мощность света, излучаемого данным источником света.

Люмен (лм) - единица светового потока в системе СИ.

1 lm = 1 cd·sr

Natężenie oświetlenia (lx/luks) - w potocznym rozumieniu, to gęstość strumienia świetlnego padającego na daną powierzchnię.

Luks (lx) - jednostka natężenia oświetlenia w układzie SI.

1 lx = 1 cd·sr / m²

Illuminance (lx / lux) - in common understanding, it is the density of the luminous flux incident on a given surface.

Lux (lx) - a unit of illuminance in the SI system.

1 lx = 1 cd sr / m²

Освещенность (лк / люкс) - плотность светового потока на заданную площадь.

Единица освещенности в системе СИ.

1 lx = 1 cd·sr / m²

CRI (od ang. colour rendering index), Ra - wskaźnik oddawania barw charakteryzujący źródło światła, który określa, jak dobrze postrzegane są barwy oświetlonych przedmiotów.

Im wskaźnik ten jest wyższy, tym barwy są lepiej oddawane, a oświetlane przedmioty wyglądają naturalniej.

Wyrażony jest liczbą z przedziału od 0 do 100, gdzie 100 to światło słoneczne.

Minimum wg przepisów w UE dla opraw wewnętrznych to 80.

CRI- is an index of a light source’s ability to reveal colours. It determines how well illuminated colours are perceived.

The higher index, the better colour rendering and the illuminated objects look more natural.

It is expressed with a number from 0 to 100, where 100 is a sunlight.

The minimum according to EU regulations for indoor luminaires is 80.

CRI (colour rendering index) Индекс цветопередачи, характеризующий источник света, который определяет, насколько хорошо воспринимаются цвета освещенных объектов. Чем выше этот индекс, тем лучше передаются цвета и освещенные объекты выглядят естественнее.

Он выражается числом от 0 до 100, где 100 - солнечный свет.

Минимальное требование ЕС для светильников для внутреннего освещения - 80.

IKONY / ICONS / ИЗОБРАЖЕНИЯ



Lampa wisząca /
Pendant lamp /
Подвесные светильники



Wyciąć /
Cut out /
Вырезать



Źródło światła /
Light source /
Источник света

Stopień ochrony IP / Degree of protection IP / Степень защиты IP

Stopień ochrony jest wyrażony dwoma cyframi. Pierwsza oznacza ochronę przed ciałami stałymi. Druga to ochrona przed cieczami.

Degree of protection is expressed by two figures. The first one stands for protection against solid particles. The second one stands for protection against liquids.

Степень защиты выражается двумя цифрами. Первая цифра относится к защите от твердых веществ, вторая, к защите от жидкостей.

| 1 cyfra / 1st figure / 1-ая цифра | |
|-----------------------------------|---|
| IP0... | Brak ochrony / Not protected / Нет защиты |
| IP1... | Ochrona przed ciałami stałymi większymi niż 50 mm / Protected against solid objects greater than 50 mm / Защита от попадания твердых веществ > 50 мм |
| IP2... | Ochrona przed ciałami stałymi większymi niż 12 mm / Protected against solid objects greater than 12 mm / Защита от попадания твердых веществ > 12 мм |
| IP3... | Ochrona przed ciałami stałymi większymi niż 2,5 mm / Protected against solid objects greater than 2,5 mm / Защита от попадания твердых веществ > 2,5 мм |
| IP4... | Ochrona przed ciałami stałymi większymi niż 1 mm / Protected against solid objects greater than 1 mm / Защита от попадания твердых веществ > 1 мм |
| IP5... | Ochrona przed pyłem / Protected against dust infiltration / Защита от попадания пыли |
| IP6... | Ochrona ryłuszczelna / Totally protected against dust infiltration / Полная защита от попадания пыли |

| 2 cyfra / 2nd figure / 2-ая цифра | |
|-----------------------------------|--|
| IP..0 | Brak ochrony / Not protected / Нет защиты |
| IP..1 | Ochrona przed padającymi kroplami wody / Protected against vertically falling water drops / Защита от попадания капель воды в вертикальном падении |
| IP..2 | Ochrona przed padającymi kroplami wody przy wychyleniu do 15° / Protected against falling water drops up to 15° from the vertical / Защита от попадания капель воды под углом не более 15° |
| IP..3 | Ochrona przed natryskiwana wodą / Protected against rain / Защита от дождя |
| IP..4 | Ochrona przed bryzgami wody / Protected against splashing water / Защита от брызг воды |
| IP..5 | Ochrona przed strugami wody / Protected against water jets / Защита от струи воды |
| IP..6 | Ochrona przed falami / Protected against powered water jets / Защита от сильной струи воды |
| IP..7 | Ochrona przed zanurzeniem / Protected against temporary immersion / Защита от временного погружения |
| IP..8 | Ochrona przed głębokim zanurzeniem / Protected against continuous immersion / Защита от продолжительного погружения |

| Material | Materiał | Материал |
|---------------------|------------------------|----------------------------|
| Brass plated steel | Stal mosiądzowana | Сталь с латунным покрытием |
| Chrome plated steel | Stal chromowana | Хромистая сталь |
| Composite | Kompozyt | Композитный материал |
| Concrete | Beton architektoniczny | Архитектурный бетон |
| Fabric | Tkanina | Ткань |
| Glass | Szkoło | Стекло |
| Metallized glass | Szkoło metalizowane | Металлизированное стекло |
| Painted steel | Stal lakierowana | Лакированная сталь |
| Plastic | Tworzywo sztuczne | Пластик |
| Plywood | Sklejka | Фанера |
| Solid brass | Lity mosiądz | Твердой латуни |
| Steel | Stal | Сталь |
| Velvet | Aksamit | Бархат |

 Oprawy oznaczone tym symbolem nie wolno okrywać materiałem termoizolacyjnym.
Fittings marked with this symbol must not be covered with thermal insulation materials.
Светильники, обозначенные этим символом, нельзя покрывать термоизоляционным материалом.

 Klasa ochronna druga oznacza, że oprawa posiada podwójną izolację ochronną, a przewód ochronny (żyła żółto-zielona) nie może być podłączony do oprawy oświetleniowej.
Protection class II means that the fittings are equipped with a double protective insulation, and the green and yellow protective conductor must not be connected to the fitting.
Второй защитный класс обозначает светильник с двойной защитной изоляцией, а защитный желто-зеленый провод не должен подключаться к светильнику.

 Klasa ochronna pierwsza oznacza, że oprawa musi być podłączona za pomocą przewodu ochronnego (żyła żółto-zielona) do przewodu lub zacisku uziemiającego.
Protection class I means that the fitting must be connected with the yellow and green protective conductor to the grounding wire or terminal.
Первый защитный класс обозначает, что светильник должен быть подключен с помощью защитного желто-зеленого провода к заземленному проводу или зажиму.

 Klasa ochronna III oznacza, bezpieczeństwo elektryczne gwarantowane przez bardzo niskie zasilanie (poniżej 50 V). Bez uziemienia.
Protection class III means, that electrical safety is guaranteed by a very low power supply (less than 50 Volt). No grounding.
Класс III электрическая безопасность гарантирована подачей электроэнергии низкого напряжения (меньше чем 50 вольт).

 Oprawy oznaczone tym symbolem wolno instalować wyłącznie na podłożach niepalnych.
Fittings marked with this symbol are suitable for installation only on nonflammable surfaces.
Светильники, обозначенные этим символом, можно устанавливать только на негорючих поверхностях.

 Zgodność produktów z ukraińskimi normami.
Ukrainian standards compliant.
Соответствие продукции украинским стандартам.

 Zgodność z normami Unii Europejskiej.
EU standards compliant.
Соответствие стандартам Европейского Союза.

 Zgodność produktów z normami Euroazjatyckiej Unii Gospodarczej.
EAEU standards compliant.
Соответствие продукции стандартам Евразийского экономического союза.

 Do użytku zewnętrznego.
Exterior use only.
Для внешнего использования.

 Do wewnętrznego użytku.
Interior use only.
Для внутреннего использования.

 Do stosowania wewnątrz i na zewnątrz.
Interior and exterior use.
Для внутреннего и внешнего использования.

 Zużyte oprawy oświetleniowe są surowcami wtórnymi - nie wolno wyrzucać ich do pojemników na odpady domowe, mogą zawierać substancje niebezpieczne dla zdrowia i życia ludzkiego oraz środowiska. Zgodnie z dyrektywą WEEE 2012/19/UE użytkownik zobowiązany jest do oddania opraw do punktu zbierania zużytego sprzętu, co przyczyni się do ochrony środowiska naturalnego.
Used lighting fixtures are recyclable materials - they must not be disposed of in household waste containers as they may contain substances hazardous to human health or life as well as to the natural environment. In accordance with Regulation WEEE 2012/19 /EU, luminaire user is obliged to return a used lighting fixture to a waste appliance collection point, which will contribute to the protection of the natural environment.
Использованные осветительные приборы являются вторсырьем, их нельзя выбрасывать в контейнеры с хозяйственными отходами, потому что они могут содержать в себе вещества, опасные для здоровья и жизни человека, и вредные для окружающей среды. Согласно директиве WEEE 2012/19/UE, потребитель обязан сдать осветительные приборы в пункт сбора использованного оборудования, что положительно влияет на окружающую среду.

KODY KOLORÓW / COLOUR CODES / ЦВЕТОВЫЕ КОДЫ



ALPHABETICAL INDEX / ALFABETYCZNY SPIS TREŚCI

| | | |
|------------------------------------|-------------------|--------|
| A | DOVER | 81 |
| | E | |
| ADAPTER CTLS. | EGG M | 66 |
| ADAPTER PROFILE | EYE L | 50-51 |
| | EYE M | 50-51 |
| B | G | |
| BARREL L | GEOMETRIC A | 83 |
| BARREL THIN S | GEOMETRIC B | 83 |
| BARREL WIDE S | GEOMETRIC C | 83 |
| BULB GLASS BALL LED, E27, 8W | GSTAR | 74 |
| BULB LED G9, 4W | H | |
| BULB LED G9, 7W | HERMANOS A | 62 |
| BULB LENS LED G9, 3W | HERMANOS B | 62 |
| BULB VINTAGE LED E27, 4W | HERMANOS C | 62 |
| C | L | |
| CABLE E27 | LASER 490 | 54, 57 |
| CABLE G9 | LASER 750 | 54, 57 |
| CABLE G9 SB | LASER 1000 | 54, 57 |
| CABLE GU10 | LUKSOR L | 71 |
| CABLE WITH SWITCH | LUKSOR S | 71 |
| CANDY | M | |
| CANOPY A | MONACO | 37 |
| CANOPY A MINI | MOUNTING A | 108 |
| CANOPY B 1500 | MOUNTING B | 109 |
| CANOPY B 780 | MOUNTING C | 109 |
| CANOPY C 1200 | P | |
| CANOPY C 780 | PEAR L | 45 |
| CANOPY D 780 | PEAR M | 45 |
| CANOPY E | PEAR S | 45 |
| CANOPY F | PICO A | 72 |
| CANOPY H | PICO B | 72 |
| CONE L | PICO C | 72 |
| CONE M | POLARIS | 34 |
| CONE S | | |
| CYLINDER L | | |
| CYLINDER M | | |
| CYLINDER S | | |
| D | | |

R

REFLECTOR LED, GU10, R50, 7W 110

S

SNOWBALL 120..... 38

SNOWBALL 160..... 39

SPHERE L 40

SPHERE M..... 40

SPHERE S 40

SPHERE XL..... 40

STRAW M..... 49

STRAW S..... 49

W

WAVE L..... 70

WAVE S..... 70

WHEEL 77

Z

ZENITH L..... 65

ZENITH M..... 65

ZENITH S..... 65

PROGRESSIVE CODE INDEX / INDEKS LAMP



| INDEX | PAGE/STRONA | INDEX | PAGE/STRONA | INDEX | PAGE/STRONA | INDEX | PAGE/STRONA |
|-------|-------------|-------|-------------|-------|-------------|-------|-------------|
| 7318 | 109 | 8405 | 109 | 8486 | 57 | 8527 | 40 |
| 7320 | 109 | 8406 | 87 | 8487 | 57 | 8528 | 40 |
| 7503 | 110 | 8408 | 87 | 8491 | 87 | 8530 | 40 |
| 7504 | 110 | 8410 | 87 | 8492 | 87 | 8531 | 40 |
| 8034 | 62 | 8411 | 86 | 8493 | 87 | 8532 | 45 |
| 8035 | 62 | 8413 | 86 | 8495 | 86 | 8533 | 45 |
| 8036 | 62 | 8414 | 86 | 8496 | 86 | 8534 | 45 |
| 8065 | 65 | 8415 | 88 | 8497 | 86 | 8535 | 49 |
| 8066 | 65 | 8416 | 89 | 8500 | 89 | 8536 | 49 |
| 8067 | 65 | 8417 | 95 | 8501 | 88 | 8537 | 48 |
| 8068 | 65 | 8418 | 94 | 8503 | 88 | 8538 | 48 |
| 8070 | 65 | 8421 | 92 | 8504 | 89 | 8540 | 48 |
| 8071 | 65 | 8422 | 93 | 8506 | 94 | 8541 | 48 |
| 8281 | 96 | 8423 | 77 | 8507 | 95 | 8542 | 48 |
| 8282 | 96 | 8424 | 77 | 8508 | 94 | 8543 | 48 |
| 8347 | 110 | 8425 | 83 | 8510 | 95 | 8544 | 48 |
| 8348 | 110 | 8447 | 110 | 8511 | 94 | 8545 | 48 |
| 8360 | 98 | 8463 | 81 | 8512 | 92 | 8546 | 48 |
| 8361 | 98 | 8464 | 81 | 8513 | 92 | 8547 | 106 |
| 8393 | 109 | 8465 | 83 | 8514 | 92 | 8548 | 106 |
| 8394 | 109 | 8466 | 83 | 8516 | 92 | 8550 | 106 |
| 8395 | 108 | 8480 | 51 | 8518 | 92 | 8551 | 106 |
| 8396 | 108 | 8481 | 51 | 8520 | 93 | 8552 | 103 |
| 8400 | 49 | 8482 | 51 | 8521 | 93 | 8553 | 103 |
| 8401 | 49 | 8483 | 51 | 8522 | 93 | 8554 | 105 |
| 8402 | 49 | 8484 | 50 | 8524 | 93 | 8555 | 105 |
| 8403 | 49 | 8485 | 50 | 8526 | 93 | 8556 | 105 |

| INDEX | PAGE/STRONA | INDEX | PAGE/STRONA | INDEX | PAGE/STRONA | INDEX | PAGE/STRONA |
|-------|-------------|-------|-------------|-------|-------------|-------|-------------|
| 8557 | 105 | 8615 | 100 | 8656 | 100 | 10205 | 37 |
| 8558 | 104 | 8616 | 100 | 8658 | 100 | 10248 | 54 |
| 8560 | 104 | 8617 | 101 | 8660 | 100 | 10250 | 54 |
| 8561 | 104 | 8618 | 100 | 8661 | 100 | 10251 | 54 |
| 8562 | 104 | 8620 | 101 | 8662 | 100 | 10252 | 54 |
| 8563 | 102 | 8621 | 100 | 8663 | 100 | 10253 | 54 |
| 8565 | 102 | 8622 | 100 | 8664 | 100 | 10254 | 54 |
| 8567 | 57 | 8623 | 100 | 8665 | 100 | 10255 | 54 |
| 8568 | 57 | 8624 | 100 | 8666 | 100 | 10256 | 54 |
| 8570 | 57 | 8625 | 100 | 8667 | 100 | 10257 | 54 |
| 8571 | 57 | 8626 | 100 | 8668 | 100 | 10261 | 61 |
| 8572 | 57 | 8627 | 100 | 8670 | 100 | 10262 | 61 |
| 8573 | 57 | 8628 | 101 | 9173 | 110 | 10263 | 61 |
| 8576 | 74 | 8630 | 101 | 9177 | 111 | 10264 | 102 |
| 8585 | 100 | 8631 | 100 | 9178 | 110 | 10267 | 38 |
| 8588 | 72 | 8632 | 100 | 9180 | 110 | 10268 | 39 |
| 8590 | 72 | 8633 | 101 | 9197 | 110 | 10270 | 60 |
| 8591 | 72 | 8634 | 100 | 9794 | 111 | 10271 | 60 |
| 8592 | 71 | 8635 | 101 | 9795 | 111 | 10274 | 103 |
| 8593 | 71 | 8636 | 100 | 9796 | 111 | 10275 | 103 |
| 8594 | 100 | 8637 | 100 | 9797 | 111 | 10327 | 74 |
| 8596 | 71 | 8638 | 100 | 10017 | 102 | 10328 | 45 |
| 8597 | 71 | 8640 | 100 | 10018 | 102 | 10330 | 45 |
| 8600 | 70 | 8641 | 101 | 10195 | 65 | 10331 | 45 |
| 8601 | 100 | 8645 | 100 | 10196 | 65 | 10336 | 102 |
| 8602 | 70 | 8647 | 100 | 10197 | 65 | 10337 | 101 |
| 8604 | 70 | 8648 | 100 | 10199 | 35 | 10338 | 101 |
| 8605 | 70 | 8650 | 100 | 10200 | 34 | 10340 | 101 |
| 8607 | 66 | 8651 | 100 | 10201 | 34 | 10341 | 101 |
| 8611 | 101 | 8652 | 100 | 10202 | 35 | 10342 | 101 |
| 8612 | 101 | 8653 | 100 | 10203 | 37 | 10343 | 101 |
| 8614 | 101 | 8654 | 100 | 10204 | 37 | | |



Nowodvorski
LIGHTING

 Nowodvorski sp.j.
ul. Bojemskiego 11
42-202 Częstochowa
POLAND

 +48 34 344 91 10 / 11
 nowodvorski@nowodvorski.com
 www.nowodvorski.com



Design & production

GRAFFITI
CREATIVE PEOPLE
www.graffiti.com.pl



www.nowodvorski.com